

INSTRUCTION MANUAL
SteadyView™ Tension Indicator
Wall Mount

5 YEAR WARRANTY

217 Pickering Road
Rochester, NH 03867 U.S.A.

For assistance, please call:

- TECHNICAL SERVICE** - Installations, Start-Up, Troubleshooting, Repairs, Field Service, Returns.
- CUSTOMER SERVICE** - Replacement Parts, Individual Products, Questions about Orders, Manuals.
- SALES** - Product Information, Systems Application Questions, Placing orders for standard products and special systems.

Telephone: (603) 332-6150

Fax: (603) 332-3758

E-Mail : info@dfc.com Internet: www.dfc.com

©1999 Dover Flexo Electronics, Inc. All rights reserved.

Dover Flexo Electronics has made reasonable effort to ensure accuracy of this document. However, NO WARRANTY, whether expressed or implied, is given regarding the completeness or correctness of information in this document. Dover Flexo Electronics shall not be held liable for damages of any kind arising from the use of this document. Dover Flexo Electronic reserves the right to make changes, additions, and deletions to this document without notice and without obligation.

TABLE OF CONTENTS

SECTION ONE	DESCRIPTION	PAGE
1.1	Description	1
1.2	Front Panel	1
1.3	Operator Controls	2
1.4	Specifications	3
1.5	Standard Features	3
	Standard Tension Outputs	3
	Digital Display	3
	LED Status Lights	3
	Tension Limit Switch	3
	Serial Interface	3
	Foreign Languages	3
1.6	Options	3
	Extended Range	3
	Non-standard Meter Scale	3
1.7	Accessories	3
SECTION TWO	INSTALLATION	
2.1	Dimensions	4
2.2	Selection of Mounting Location	4
2.3	Installation Instructions	4
2.4	Preparing the Power Cord	5
2.5	Electrical Connections	5
2.6	Transducer Connections	6
SECTION THREE	CALIBRATION AND SETUP	
3.1	Opening the Indicator	7
3.2	About the Setup Process	7
3.3	Collecting Information about your Application	7
3.4	How the Menus are Organized	8
3.5	Programming the Unit	8
3.6	Setup for Foreign Language Operation	12
3.7	Changing the Transducer Excitation Voltage	12
3.8	Signal Output Connections	13
3.9	Connections for TLS Function	14

SECTION FOUR	OPTIONAL SERIAL INTERFACE	
4.1	Introduction	15
4.2	Changing the Type of Serial Interface	15
4.3	Serial Interface Connections	15
4.4	Default Connection Settings and Host Computer Setup	16
4.5	Command Types - Initial Communications	16
4.6	Summary of Commands - Host to SteadyView Communications	17
4.7	Detailed Description - Supervisory Level Commands	18
4.8	Detailed Description - Run Level Commands	19
4.9	Detailed Description - Menu Level Commands	21
SECTION FIVE	CARE AND MAINTENANCE	23
SECTION SIX	TROUBLESHOOTING	
6.1	Error Messages on the Display	24
6.2	Other Error Conditions	25
SECTION SEVEN	REPLACEMENT PARTS	26

APPENDICES

A	Quick Setup Instructions	27
B	PC Boards	30
C	Transducer Electrical Connections	31
D	Typical Tensions	35
	TERMS AND CONDITIONS OF SALE	36
	INDEX	37

LIST OF ILLUSTRATIONS

<u>FIGURE</u>	<u>DESCRIPTION</u>	<u>PAGE</u>
1	Front Panel	1
2	Dimensions	4
3	Preparing the Power Cord	5
4	Electrical Connections	5
5	Web Path	10
6	Transducer Excitation Switch	13
7	SW107 on Front Board	13
8	Web Path	28
9	Power Board	30
10	Front Board	30
11	Model C and UPB Transducer Wiring	31
12	RF Transducer Wiring	32
13	TR and NW Transducer Wiring	33
14	LT Wiring	34

PRODUCT ORDERING CODE

407 - 1 0 0 0 0 - 0250 - X...

Input Voltage	Output	Chassis	Serial Interface	Language	Meter Scale	Options
1 = 115v 2 = 230v	0 = 0-10Vdc 1 = 0-20mA 2 = 4-20mA	0= Standard	0 = RS232D 1 = RS422 2 = RS485	0 = English 1 = German 2 = Spanish 3 = French 4 = Italian	0001 = 0 - 1 0005 = 0 - 5 0010 = 0 - 10 0025 = 0 - 25 0050 = 0 - 50 0100 = 0 - 100 0150 = 0 - 150 0250 = 0 - 250 0500 = 0 - 500 1000 = 0 - 1000	X = NO OPTIONS B = Extended Range E = Non-Standard Meter Scale Z = Special (SPR)

1.1 DESCRIPTION

The SteadyView tension indicator is a versatile, accurate, yet low-cost instrument designed to indicate process web tension. Its small size and low cost allow it to be used in many applications which previously required expensive equipment. The unit can be used to display running web tension and will allow the machine operator to produce higher quality product at lower cost.

Features on this unit include a relay output activated by either high or low tension, or both (which can be used to indicate web breakage); and a serial output which can be used for data collection, to print web tension over a period of time, or to commands the unit remotely.

1.2 FRONT PANEL

Figure 1 shows the front panel of the SteadyView unit. Once the unit has been set up, it will show the web tension as soon as power is turned on. A typical display is shown below. The measurement appears on the left side of the display, and the units used for the measurement appear on the right.

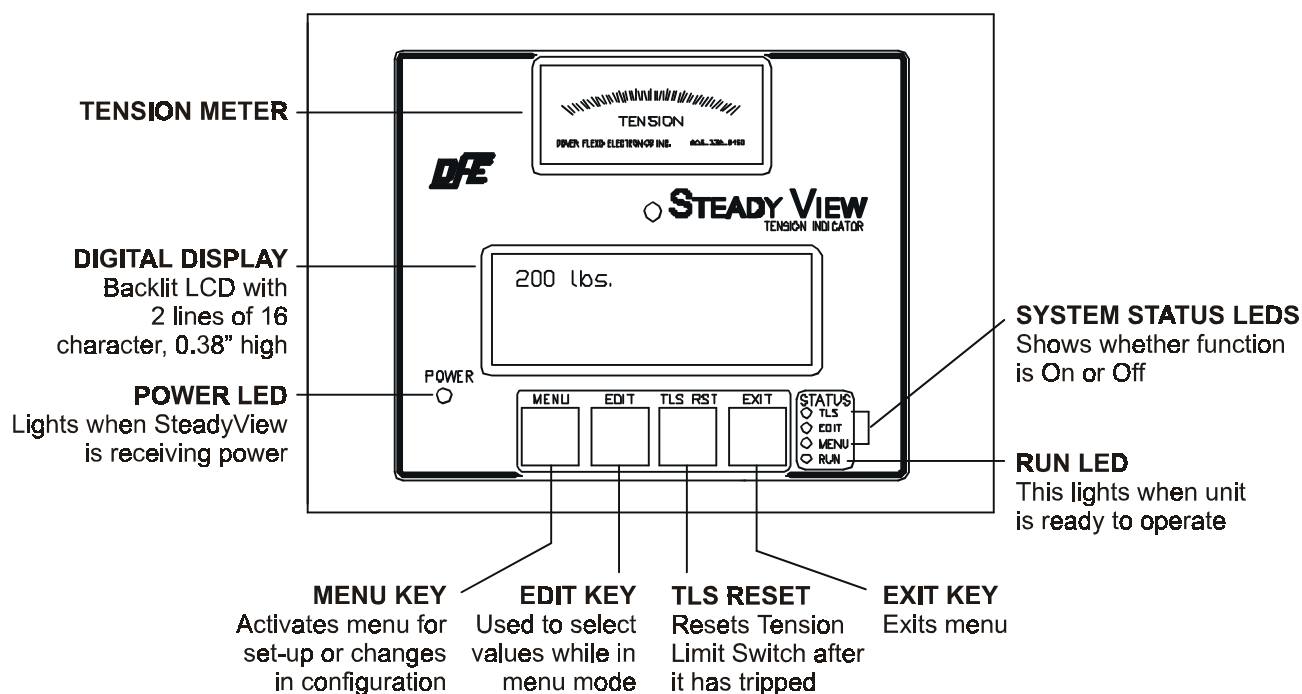

Figure 1 - FRONT PANEL

1.3 OPERATOR CONTROLS

There are four keys which will be used by the machine operator. All except the TLS Reset are only used during set-up. You do not have to memorize the functions of these keys, but they are described here in case you have questions about the functions.

MENU key -

The Menu key has four possible functions, depending on what the SteadyView is doing at the moment:

- When the unit is running normally and measuring tension (Run mode), pressing Menu begins the set-up process.
- If the set-up process has already begun (Menu mode), pressing Menu moves you to the next menu item.
- If you are entering a number for a value (Edit mode), pressing Menu moves the editing position one digit to the right.
- When you are ready to save the set-up values (Store or Abort mode), pressing Menu saves the values you have selected and takes you back to Run mode.

EDIT key -

The Edit key has three possible functions, depending on what the SteadyView is doing at the moment:

- During the set-up process (Menu mode), it allows you to change the value of the menu item being displayed.
- If you have used Edit to select an item or digit (Edit mode), you can continue to press Edit to select between possible choices. If you are entering a number, each time you press Edit you increase the value of the flashing digit by one.
- When you are ready to save the set-up values (Store or Abort mode), press Edit to go back and check your changes without storing them.

TLS RESET key -

The SteadyView has a “Tension Limit Switch ”function. This function can be used to produce an alarm if the tension on the web is too high or too low. During set-up, you can select the high and low limits. Once the unit is running, if the tension moves outside of the normal limits, the LED above the TLS Reset button will light. The SteadyView may also be connected to send a signal to another piece of machinery.

- The TLS function may be set to reset itself automatically, once the tension is normal again. If the function is set this way, the LED will go out by itself.
- The function may also be set to “Latch.” To reset the function, the operator must press the TLS Reset key.
- This function may also be set to “Off” if it will not be used.

EXIT key -

The Exit key has three possible functions, depending on what the SteadyView is doing at the moment:

- During the set-up process (Menu mode), pressing Exit takes you to Store or Abort mode. From here you can save your changes, go back and try again, or go back to Run mode without saving changes.
- If you have used Edit to select an item or digit (Edit mode), pressing Exit returns you to Menu mode.
- If you are ready to save the set-up values (Store or Abort mode), Exit allows you to go back to Run mode without saving any of the changes you have just made.

1.4 SPECIFICATIONS

Power input:	115/230VAC (switch selectable) 50/60 Hz, 1 Amp
Tension signal outputs:	Analog voltage output 0-10 Vdc or 0-20mA or 4-20mA tension signal (switch selectable)
Transducer excitation:	5Vdc (10 Vdc extended range) switch selectable
Transducer input signal:	500 mVdc per pair at rated load (1000 mVdc XR)
Zero range:	95% of transducer rating
Tension limit switch outputs:	Normally open and normally closed relay contacts rated at 250 mA DC
Mating Transducer Cable Connectors	MS3106A-10SL-3S
Serial Interface Connector	9 pin D-SUB Male Connector
Relative humidity	5% to 95%, non-condensing
Operating Temperature Range	32° F to 100° F (0°C to 38°C)
Standard Meter Scales	0 to 1, 5, 10, 25, 50, 100, 150, 250, 500, 1000
Weight	6.5 lbs. (1.36 kg.)

1.5 STANDARD FEATURES

- ! **0-10Vdc, 0-20mA, and 4-20mA** Tension Outputs, switch selectable.
- ! **Digital Display.** Backlit LCD with 2 line, 16 character display for instant readout of tension and units being measured, or text in specific modes.
- ! **LED Status Lights.** Shows what functions are in use.
- ! **Tension Limit Switch (TLS).** Activates a preset adjustable trip point. Protects machinery from excessive tension and can be used to detect web breaks.
- ! **Serial Interface.** RS232D serial computer interface allows communication with computers for data collection, and remote command of the SteadyView..
- ! **German, French, Spanish, or Italian** languages available in menu.

1.6 OPTIONS

- ! **Extended Range.** 10Vdc excitation for extended range transducers. Allows measurement of a much lower tension than usual. Transducers must have the XR option.
- ! **Non-Standard Meter Scale.** Any meter scale other than the standard ones listed above.
- ! **Optional Serial Interface.** RS422 or RS485

1.7 ACCESSORIES

- ! **Interconnection Cables.** For connecting SteadyView™ to tension transducers.

2.1 DIMENSIONS

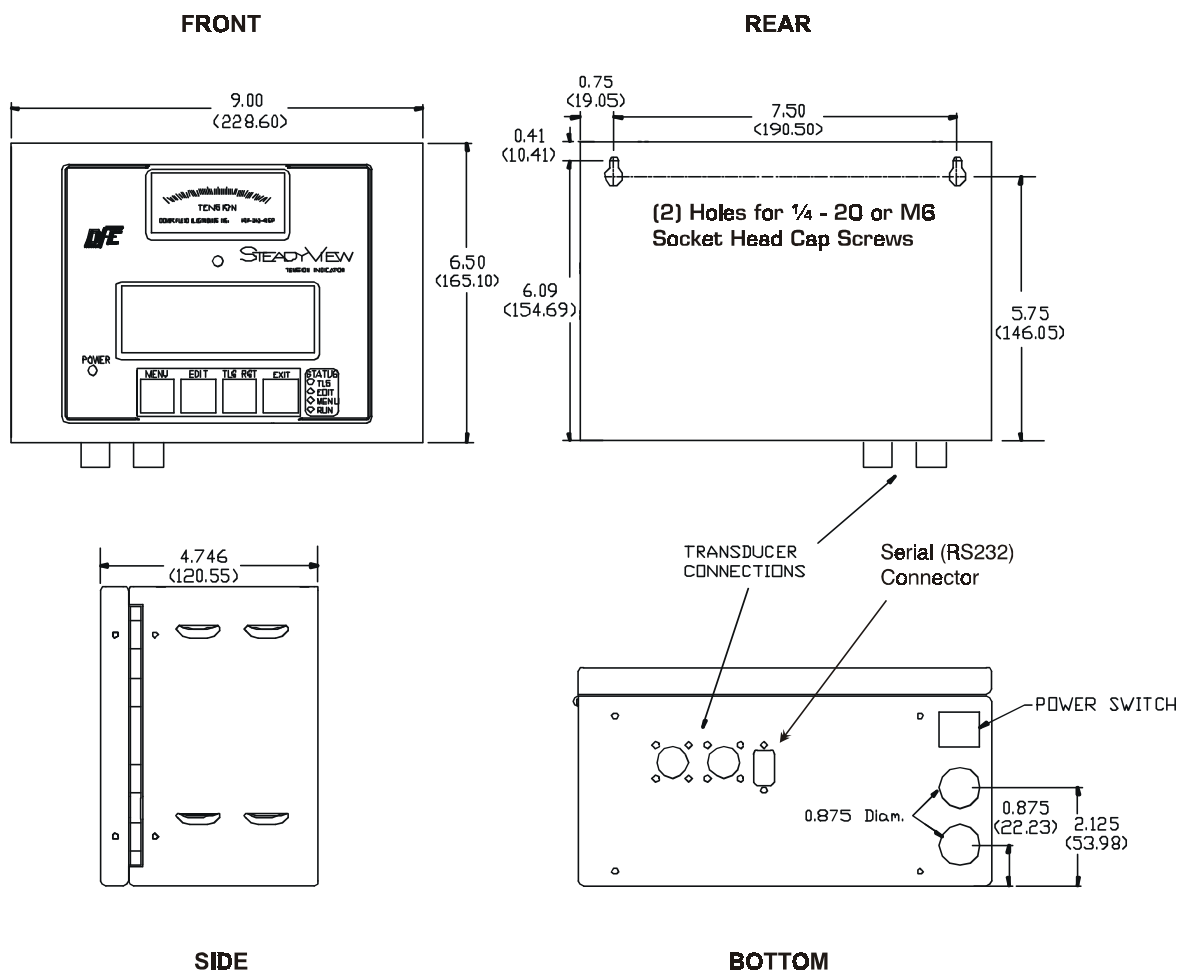

Figure 2 - DIMENSIONS

2.2 SELECTION OF MOUNTING LOCATION

Select a location on the machine frame or a wall that will be convenient for the machine operator to operate the indicator and to see the tension meter and display easily. Be sure the location is free from vibration, and is dry and clean. Take care to choose a place that the indicator won't be struck and damaged by anything or anyone. Refer to the dimensions listed in Figure 2 for exact fit. Be sure all connecting wiring is protected.

2.3 INSTALLATION INSTRUCTIONS

The enclosure is fastened to the mounting surface you have chosen by two socket head cap screws. Install the screws in the mounting surface to the dimensions shown in Figure 2. Leave them loose - about six turns. Position the keyholes in the back panel of the enclosure over the screws and slide the enclosure down until it locks in place. Open the SteadyView door to tighten the mounting screws. (Refer to Section 3.1 for opening instructions)

2.4 PREPARING THE POWER CORD

- The cord must be equipped with a third grounding wire, and the plug must have three prongs.
- Strip the free end of the wires evenly as shown in Fig. 3.

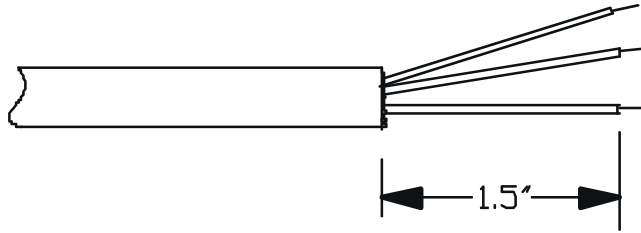

Figure 3 - PREPARING POWER CORD

2.5 ELECTRICAL CONNECTIONS (Refer to Fig. 4 below)

- The Power Voltage Selection switch on the power PCB (SW201) sets the operating voltage of the SteadyView unit. Check that this is set correctly.
- Connect the exposed wires of the power cord that you prepared above to the power terminal block (TB201). Use terminals L1 and L2. Connect the ground wire to PE.
- Refer to the drawing below for electrical connections of the other functions. Make the connections to J203 as appropriate.

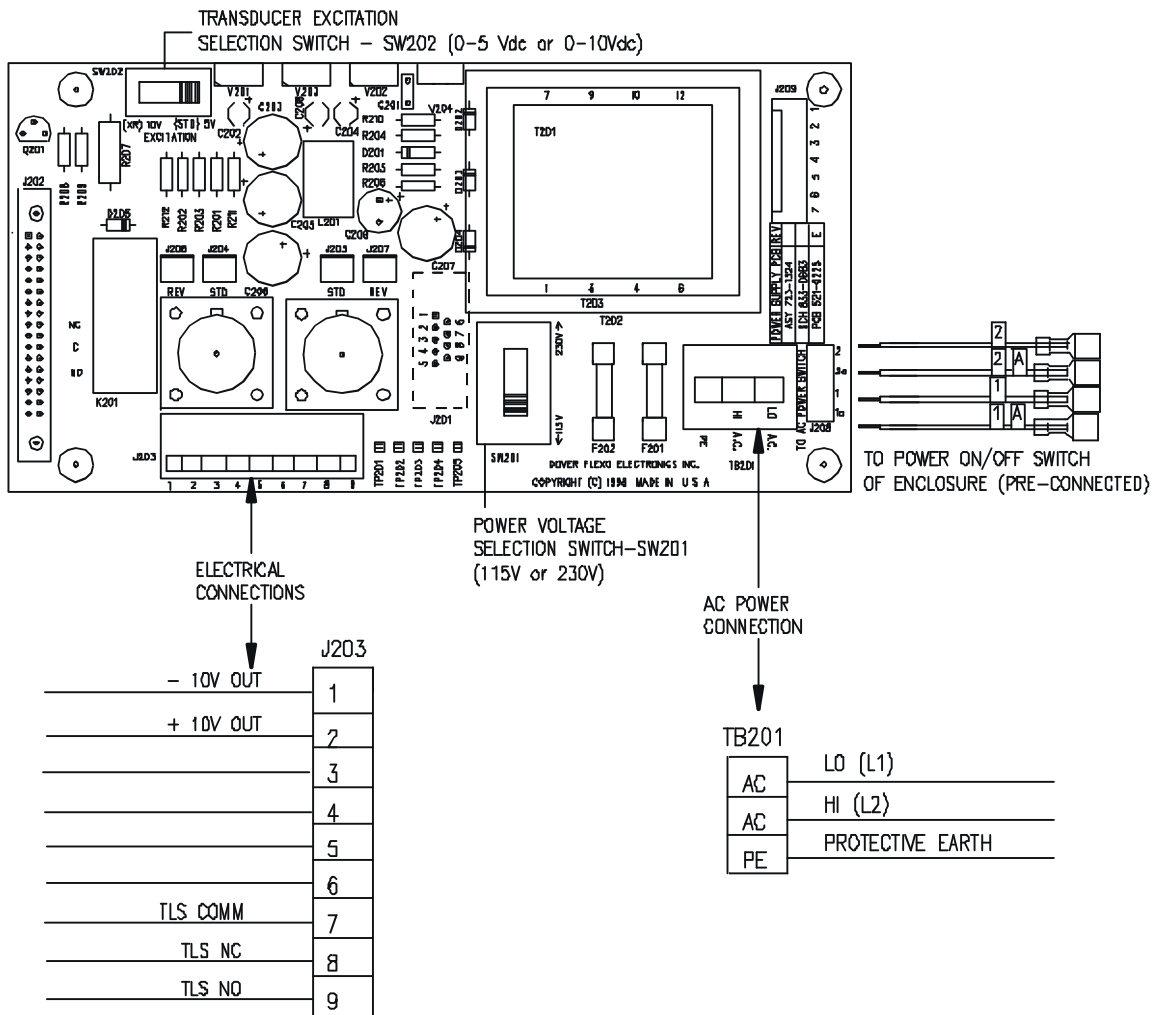

Figure 4 - ELECTRICAL CONNECTIONS

2.6 TRANSDUCER CONNECTIONS

- a. The sensor roll includes one or two transducers. These parts sense the tension in the material, and report back to the SteadyView unit. Make the connections for the transducers. If you are using pre-wired connectors supplied by Dover Flexo Electronics, plug in the connectors.

Transducer cable types:

TRANSDUCER MODEL	CABLE LENGTH	PART NUMBER	CABLES NEEDED
Model C , RS, and UPBH & V transducers with straight connectors	15' (4,5m)	721-0085	2
Model C, RS, and UPBH & V transducers with right angle connectors	15' (4,5m)	721-0083	2
Model NW , TR2 & TR3 transducers	15' (4,5m)	721-0962	1
Model RFA, LT, TR1 & NW* Transducers <i>* Used on NW's with Short Connector Housing</i>	15' (4,5m)	721-0995	1

This unit has been designed to be easy to setup. Experienced users should see Appendix A for quick set up instructions. We have included detailed instructions here to be comprehensive, and to answer any questions you may have. For foreign language setup go to section 3.6 on page 12.

3.1 OPENING THE INDICATOR

The loosening of the hex screw on the right side is all that is needed to open the cover. The tool required for this is a M3 (HEX) allen wrench. Opening up the unit is necessary for the following things to be accomplished:

- Check Serial Tag Product Code. Confirm with Product Code before page one of manual for outputs and options ordered.
- Check the signal output (analog voltage or current loop). If change is needed - see Section 3.8.
- Check the transducer excitation voltage (5V or 10V). If change is needed - see Section 3.7.
- Check serial interface. If change is needed - see Section 4.2.

CAUTION!

Many of the parts inside the SteadyView can be damaged by sparks caused by static electricity. You can prevent this by making sure both you and your work surface are properly grounded before you open the case of the indicator.

3.2 ABOUT THE SETUP PROCESS

The set-up process is relatively simple. To set the unit up, you will work through each of the menus. In each menu, you will make a choice or enter a number. You will have as many chances as you want to try again. You can't damage the equipment by entering a wrong value.

If the SteadyView unit is new (that is, one without any programmed values), you must go through some of the menus, even if those menus are already set correctly. You cannot use the Menu key to skip over these menus. For example, on a new indicator, the menu will default to show a choice of "lb" for UNIT. Even if you want to use this choice, you have to go to Edit mode (by pressing Edit), select "lb," and press Exit. The unit will not allow you to go to the next menu until you do this.

The SteadyView will remember your settings until they are changed. If you want to erase all of the settings stored in the unit, press and hold the Menu, Edit and Exit keys for 5 seconds. The three LEDs will then flash in sequence.

3.3 COLLECT INFORMATION ABOUT YOUR APPLICATION

Before you start, decide on these values:

- What units will the SteadyView use for measuring (ounces, grams, etc.)? Will the SteadyView display the load on the whole width of the sensor roll, or the load per unit of web width (pounds per inch, grams per centimeter, etc.)? If you are not sure which units to use, contact Dover Flexo Electronics.

Write the units used for the display here: _____

- What is the highest value you will want the unit to display? (The lowest value will probably be zero).

Write the planned display range here: _____

- How wide is the web?

Write the web width here: _____

- The unit will be "calibrated" by hanging a weight from the sensor roll. This should be about 50% to 90% of the highest value you plan to display. How heavy a weight will you use during calibration?

Write the calibration weight here: _____

3.4 HOW THE MENUS ARE ORGANIZED

When the unit is running normally, there is just one display. It shows the tension, and the units used to make the measurement.

During set-up, there are 10 menus. They are arranged in a loop. This means that, if you keep moving through the menus, you will come back to the starting point. To start the process, you press Menu. Press Menu again to move from one menu to another. All of the menus do not appear every time you go through the list. Some of them appear only if you make a change in another menu.

Here is a list of the menus:

<u>Menu</u>	<u>Function</u>
UNIT	Choose the units used for measurement
RNG	Set the upper end of the indicated range
IN (or cm)	Set the web width (optional– appears only if PLI, ozi, Kgcm, gcm or Ncm is selected in Unit menu.)
ZERO?	Zero the system
WT	Enter the calibration weight (appears only if you change Range)
CAL?	Do the calibration
REZERO?	Re-zero
TLS	Set up the tension limit switch
LO	Set the low limit for the tension limit switch (appears only if you change the function of the tension limit switch) or the calibration.
HI	Set the high limit for the tension limit switch (appears only if you change the function of the tension limit switch) or the calibration.
ADDR	Set the address used by the serial interface to connect the SteadyView to a host computer (if there is more than one SteadyView unit)

Once you reach the last menu, if you press the Menu key again, you will roll around to the UNIT menu again.

3.5 PROGRAMMING THE UNIT

STEP 1 - Choose the units used for measurement

- a. Turn on the power switch on the bottom of the unit. If the unit is new, the three LEDs on the front will flash in sequence. This shows that none of the setup values have been stored yet.
- b. The next menu will say:
 UNIT lb
 Choose the units - pounds, ounces, grams, etc. One of these units will appear on the menu. If you want to change the units, press Edit.
- c. Keep pressing Edit until you see the units you want to use. Here are the choices:

lbs	pounds	total across whole width of web
oz	ounces	total across whole width of web
gm	grams	total across whole width of web
Kg	Kilograms	total across web
N	Newtons	total across whole width of web
ozi	ounces	per inch of web width
PLI	pounds	per inch of web width
K/M	Kilograms	per meter width
Ncm	Newtons	per centimeter of web width
gcm	grams	per centimeter of web width
- d. When you are finished press Exit to store the setting. The unit will return to this menu:
 UNIT xxx (XXX are the units selected)
- e. Press Menu to go on to the next menu.

STEP 2 - Set the upper end of the range

Use this function to set the highest value the unit will be able to measure. This value should be about 25% higher than any normal reading you will expect to see. For example, if your running tension is 100 lb., use an upper limit of 125 lb. (Note - This value is used by the measuring system - it does not affect the trip points for the TLS tension limit switch.)

- a. The Range menu looks like this:

RNG 0000

- b. What is the highest value you will want the SteadyView to be able to read? (This menu uses the units you set in the last step. For example, if you set the unit for oz = ounces, "1000" means 1000 ounces.)
- c. Press Edit to change the setting. The first digit will be underlined:

RNG 0000

- d. To change the value of the first digit, press Edit again.
- e. When the setting for the first digit is correct, press Menu to move to the next digit.

RNG 1000

- f. Use Edit to change this digit, if necessary.
- g. Press Menu to move to the next digit. Make any necessary changes using Edit.
- h. When you are finished, press Exit to return to the Range entry screen, which should show the new value. Here is an example:

RNG 1100

- i. Press Menu to go to the next menu.

STEP 3 - Set the web width

(This menu appears only if you have chosen measurement per unit of web width - ozi, PLI, Ncm, gcm or K/M).

- a. The Web Width menu shows the width of the web, using the units you have chosen:

IN 000.0

or

CM 000.0

- b. To begin making changes, press Edit. The first digit will be underlined.
- c. To increase the value of this digit, press Edit again.
- d. Press Menu to move to the next digit.
- e. When you are finished, press Exit to return to the Web Width menu.
- f. Press Menu to go to the next menu.

STEP 4 - Zero the system

In this step, you allow the SteadyView unit to weigh the sensing roll without the weight of the web. (This menu will appear only if you have changed the Range menu, or the unit is new.)

- a. The Zeroing menu looks like this:

ZERO?

- b. Press the Edit button. The menu will read:
Remove weight and press Edit
- c. Remove the web from the sensing roll. It is important to do this before taking the next step.
- d. Once the weight is off the sensing roll, press Edit. For a moment, the menu will read:

Zeroing please wait

- e. When the unit is finished, the menu will read:

ZEROED

- f. Press Menu to go to the next menu.

STEP 5 - Enter the weight used for calibration

(This menu will appear only if you have changed the Range menu, or the unit is new.)

- a. The Calibration Weight menu looks like this:

CAL WT
XXXX

During calibration, you hang a known weight from the sensor roll. You use the Calibration Weight menu to enter the weight you will be using.

The value which first appears on this menu will be the value you entered earlier for Range. You should change this to match the actual weight you use during calibration. A weight of 25 lb. to 50 lb. will usually work, if this is 25–100% of full scale. You can also take the full range figure you developed earlier, and use 25% to 100% of that. You cannot use a weight greater than your range.

- b. Press Edit to change the weight. The first digit will be underlined.

WT XXXX

- c. Press Edit again to increase the value of this digit.

- d. Press Menu to move to the next digit.

- e. When the weight is correct, press Exit to return to the Calibration Weight menu:

WT XXXX

- f. Press Menu to go to the next menu.

STEP 6 - Do the calibration

(This menu will appear only if you have changed the Range menu.)

- a. The Calibration menu looks like this:

CAL?

- b. To continue with the calibration, press Edit. The display will say:

Apply weight
AND press EDIT

- c. Hang the test weight from the sensor roll. Thread a length of rope over the center of the roll. Be sure to follow the exact path of the web. The rope must extend from the roll before the sensing roll to the roll after it. See Fig. 5. Rope may pass additional rollers but not nips or drag bars/rolls.

- d. Once the weight is on the sensing roll, press Edit to begin the calibration. The display will say:

CALIBRATING
PLEASE WAIT

When the process is finished, the menu will say:

CALIBRATED

- e. Press Menu to go to the next menu.

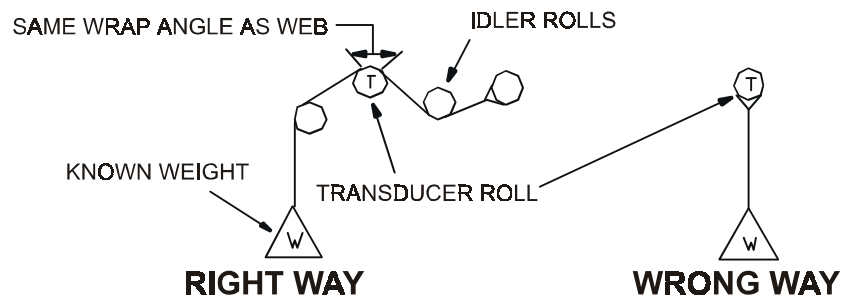

Figure 5 - WEB PATH

STEP 7 - Repeat the zeroing procedure

- a. After the SteadyView has been calibrated, it is important to complete calibration by rezeroing. The Rezeroing menu looks like this:

REZERO?

- b. Press Edit to begin the rezeroing process. The menu will say:
 Remove weight
 And press EDIT
- c. Remove the test weight and the rope you used during calibration. Also be sure the web and any other weights are removed from the sensor roll. Press Edit when the roll is ready. The menu will briefly say:
 REZEROING
- e. When the process is done, the menu will say:
 REZEROED
- f. Press Menu to go to the next menu. (To leave the set-up process and measure tension, press Exit twice, then Menu.)

STEP 8 - Set up the tension alarm (tension limit switch)

This detector signals if the tension moves outside of the high and low limits you set.

- a. The TLS Set-Up menu looks like this:
 TLS OFF
- b. If the TLS is off and you want to skip this item, press Menu. Go to Step 11.
 To set up the tension alarm, press Edit. The menu will show whether the alarm is turned on. There are three selections possible. Press Edit again to choose the function you want:
 TENSION LIMIT Tension limit switch is turned off
 OFF
 TENSION LIMIT Tension limit switch is turned on, presents an alarm only while the tension is outside
 MOMENTARY the limits, resets automatically
 TENSION LIMIT Tension limit switch is turned on, presents an alarm while the tension is outside the
 LATCHED limits, alarm continues until reset using the TLS Reset button on the front of the unit
- c. When the setting is correct, press Exit.
- d. Press Menu to go to the next menu.

STEP 9 - Set the low limit for the tension limit switch

(This menu will appear only if you have changed the function on the TLS Set-Up menu, or changed calibration.)
 If you want to turn off the low limit function, so the TLS will not respond if the tension drops, set the low limit to zero.

- a. The menu for the low limit looks like this:
 LO xxxx
- b. Press Edit to call up the first digit. Keep pressing Edit to change the digit.
- c. Press Menu to move on to the next digit. Press Edit to change this digit.
- d. Do the same with the other digits. When the setting is correct, press Exit.
 Note: If you try use too large a number for the low limit, the menu will say “Error” and return you to the beginning of this menu.
- e. Press Menu to go to the next menu.

STEP 10 - Set the high limit for the tension limit switch

(This menu will appear only if you have changed the function on the TLS Set-Up menu.)
 If you want to turn off the high limit function, so the TLS will not respond if the tension rises, set the high limit to the upper limit of the range.

- a. The menu for the high limit looks like this:
 HI xxxx
- b. Press Edit to call up the first digit. Keep pressing Edit to change the digit.
- c. Press Menu to move on to the next digit. Press Edit to change this digit.
- d. Do the same with the other digits. When the setting is correct, press Exit.
 Note: If you try use too small a number for the high limit, the menu will say “Error” and return you to the beginning of this menu.

STEP 11 - Set the address for the serial interface

The serial interface allows the SteadyView to communicate with a host computer. The host computer will need to know which address to use in communicating with each SteadyView unit on the system. Each unit must have a separate, unique address. (The possible addresses include the numbers 0 through 9 and the letters A through Z, for a total of 36 possible addresses.)

If the SteadyView will not be connected to a host computer, or if only one SteadyView will be connected, you can leave the unit with the default address of zero.

If two or more SteadyView units will be connected, you must set each unit for a unique address which is different than zero. (If two or more units are connected, none of the addresses may be zero.)

- a. Press Menu to go to the address menu:

ADDR 0

- b. If you want to leave the address setting at zero, press Menu to move on to the next menu. (This is OK if the SteadyView will not be connected to a host computer, or if only one unit will be connected).
- c. If you want to change the address setting, press Edit.
- d. Press Edit again until you see the address you want.
- e. When the setting is correct, press Exit.
- f. Press Menu to move on to the next menu.

STEP 12 - Save the settings

- a. At this point, you have made all of the set-up adjustments. Press Exit again to get this message:
Press MENU to store, EDIT to continue, EXIT to abort
- b. If you want to go through the settings again, press Edit. To start over from the beginning, press Exit. This will erase the settings. To save the new settings, press Menu. The unit will start to indicate the tension on the web.

3.6 SETUP FOR FOREIGN LANGUAGE OPERATION

The SteadyView unit may be set up to display prompts and information in several foreign languages. The options include German, Spanish, French, and Italian.

The SteadyView unit can be set up for this manually, or by commands from a host computer. For information on setup by the host computer, see Section 4.

If you want to do the setup manually, you must do the following setup procedure before you do the other setup steps listed.

- a. Hold down the Menu key as you turn on the power switch on the rear of the SteadyView unit.
- b. The display will say:

English

- c. To prepare to change the language, press Edit.

! Press Edit again to get the language you want. The options are:

Deutsch (German)

Espanol (Spanish)

Francais (French)

Italiano (Italian)

! When the correct language is displayed, press Exit.

! Press Menu to go to the other steps in the setup.

! NOTE: Remember to save the settings as mentioned in Section 3.5, Step 12, otherwise the unit will not store the selected language. Once you select a language, the SteadyView will remember this, even if the power to the unit is turned off.

3.7 CHANGING THE TRANSDUCER EXCITATION VOLTAGE (Refer to PC Boards, Appendix A)

- a. This unit can be set to provide two levels of excitation voltage. The "normal/extended range" selection switch is located towards the back of the unit on the Power PCB. When the switch actuator is toward the right of the board, the switch is in the normal or 5V excitation position. When the actuator is toward the left of the PCB, the switch is in the extended range or 10V position. The excitation voltage is marked on the silk screen on either side of the switch. Slide the switch actuator to the position appropriate for the transducer(s) you are using.

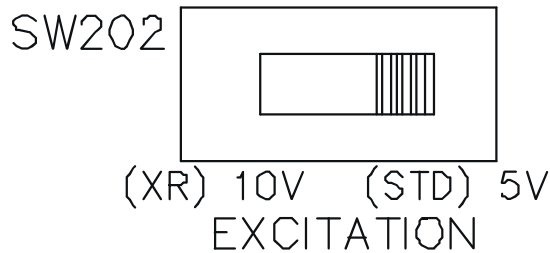

Figure 6 - TRANSDUCER EXCITATION SWITCH

CAUTION!

Do not use extended range excitation unless the transducer is designed for this. The wrong excitation voltage can damage the transducer! If in doubt about the correct excitation voltage, contact the Service Department at Dover Flexo Electronics for assistance.

- b. If you choose extended range excitation, you must also set the DIP switch SW107 mounted on the Front circuit board on the inside cover. See figure below.

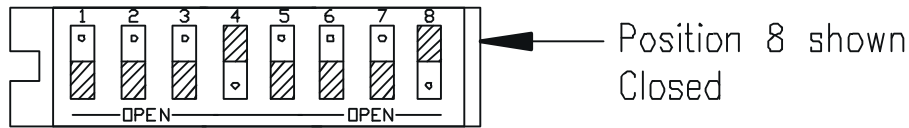

Figure 7 - SW107

To select standard range:
On SW107, position 8 closed

To select extended range:
On SW107, position 8 open

3.8 SIGNAL OUTPUT CONNECTIONS (Refer to PC Boards, Appendix A)

The terminal block on the Power PCB includes contacts for an output to a remote meter or indicator. You may select voltage or current-loop outputs. At any moment, the output here is proportional to the percentage of the indicator's full range. For example, if the indicator is set to read 0-100 ounces, and is indicating 50 ounces, the signal output will also be 50% of maximum.

- a. To select voltage output or current output, disassemble the unit as described in section 3.1. Figure 10 on page 30 shows the location of the DIP switch (SW107) on the Front board mounted on the inside cover of the unit.

To select voltage output:

On SW107, positions 1 and 2 open, positions 3 and 4 closed

(The unit is configured at the factory for 0 -10V output unless ordered otherwise - see product code).

To select current output:

On SW107, positions 1 and 2 closed, positions 3 and 4 open

If current output is selected, to select 4 to 20 mA output:

On SW107, positions 5 and 6 closed

If current output is selected, to select 0 to 20 mA output:

On SW 107, positions 5 and 6 open

- b. Make the connections on the terminal block on the Power PCB. Refer to Electrical Connections on page 5.
 - 1 (-) Output return
 - 2 (+) Output signal

3.9 CONNECTIONS FOR TENSION LIMIT SWITCH FUNCTION

- a. Make the connections for the tension limit switch function (TLS) on the left-hand terminal block on the power board. TLS is on pins 7, 8, and 9. This function provides an alarm if the tension moves too high or low. It can be used to detect a break in the web. You set the limits during the set-up process. Connections are terminal 7 (COM- Common), terminal 8 (NC- normally closed), and terminal 9 (NO- normally open).
- b. Make the other connection depending on the function you want. If the relay contacts should remain open as long as the tension is correct, use terminal 9 (NO - normally open). If the relay contacts should remain closed as long as the tension is correct, use terminal 8 (NC - normally closed).

NOTE - It is not necessary to read this section unless the SteadyView will be connected to a remote computer system.

4.1 INTRODUCTION

The SteadyView indicator is mainly intended to provide stand-alone, local indication of process tension. However, the unit also includes a serial port. This can be used to assist in initial setup, or to help collect data for a remote computer.

If the SteadyView is communicating with a remote computer, it uses a simple command/response protocol. This allows the remote computer to control all indicator modes and functions, just as if an operator was working with the control panel. To start the process, the host must transmit a command or query. The SteadyView then responds. The SteadyView cannot initiate a communications sequence by itself. All commands include a unit address for systems in which a single host computer controls a number of remote units, .

The serial port is controlled by a standard UART. The baud rate may be specified by the user.

4.2 CHANGING THE TYPE OF SERIAL INTERFACE

The SteadyView may be set to use several different serial protocols: RS232, RS422, or RS485. At the factory, the unit is set for RS232 unless ordered otherwise. The unit may be converted for the other protocols by installing optional kits. To make a selection, begin by opening the unit as described in section 3.1. Figure 10 shows the two DIP switches mounted inside the unit.

To select RS422:

- a. Install option kit per instructions.
- a. Set SW106, positions 3 and 4 Open (generally these are already open).

To select RS485:

- ! Install option kit per instructions
- ! Set SW106, positions 3 and 4 Open (generally these are already open).

4.3 SERIAL INTERFACE CONNECTIONS

A 9-pin D subminiature connector is provided on the bottom of the unit. Here are the pin assignments:

- 1 RxD
- 2 RxD*
- 3 TxD*
- 4 TxD
- 5 Ground *Null modem required

NOTE - For serial interface RS232 connections, use only pins 2, 3, and 5. In any case, do not make connections to pins other than those required for your chosen interface.

4.4 DEFAULT COMMUNICATIONS SETTINGS AND HOST COMPUTER SETUP

When the SteadyView is first powered up, the serial port uses some default settings. The first time a remote unit communicates through the serial port, it will have to use these settings:

Baud rate = 9600 Data bits = 8 Stop bits = 1 Parity bits = N

Once communication has been established using these setups, you may use the “change comm parameters” (ref. bottom of page 20) command to change the SteadyView’s communication parameters so that your computer or PLC can communicate with it.

Note: a PC running a standard Windows terminal and a null modem serial cable are minimally sufficient requirements to establish communication with the SteadyView, however, use of your own commercially available communications software is suggested.

4.5 COMMAND TYPES AND INITIAL COMMUNICATIONS

In the following command descriptions, “#” indicates SteadyView’s one-byte ASCII address from 0 through 9 and A through Z. This provides 35 possible addresses (in addition to the “0” address) for multiple unit installations. The factory default address is 0, to which all units respond. (A unit with an address other than 0 will still respond to 0).

Commands are divided into three categories: Supervisory Level, Run Level, and Menu Level. These are preceded by the characters “*”, “\$”, or “&”, respectively.

Supervisory Level Commands can be processed at any time, and consist only of the four commands “*#M”, which disables local mode and enables remote mode; “*#L”, which disables remote mode and enables local mode; “*#S” which requests operational status, and “*#B”, which requests communication parameters. Therefore, aside from status requests, the first command in a host/SteadyView communication sequence must be “*#M”, which causes the SteadyView to enter Remote Communications mode and to be able to respond to other commands on the serial interface. If the SteadyView is in Menu mode while the *#M command is issued, it is forced to exit to Run mode without storing parameters. It is therefore the responsibility of the host to assure that the unit is in Run mode before beginning remote communications to prevent lost information should someone be in the process of programming the unit.

While the unit is in the remote mode, the keypad is disabled (with one exception, noted below) in order to avoid conflicts between commands entered locally through the keypad and those entered remotely through the serial interface. Therefore if keypad functionality is to be restored the last command issued during a communications sequence must be *#L.

The SteadyView cannot enter Remote mode through keypad commands. During a remote operating session, the display behaves as if commands were issued through the keypad.

Once the Remote mode has been enabled and the SteadyView unit is in the Run mode, **Run Level commands** can be processed by the SteadyView. The Run level commands generally consist of requests for data and status inquiries.

Menu Level Commands can only be processed while the SteadyView has been placed into Menu mode by remote access. It is necessary to become familiar with the basic menu structure in order to properly navigate through the menu while in Remote mode.

Whenever the SteadyView receives a command which requires a response specific to that command (an example would be a Comm status request, for which the response would be comm status), the SteadyView responds with a prefix specific to that command, its address, and then the requested information. In this way the host has confirmation that the SteadyView processed the command correctly and that the data is valid. If the SteadyView receives a command which only requires the SteadyView to process the command, the SteadyView still acknowledges receipt of that command with the ACK (acknowledge) response, “%#A”. If the SteadyView receives a command but either does not recognize it, or recognizes it but the command is not appropriate for the menu level, or for any other reason cannot process the command, the SteadyView will acknowledge the receipt of these undefined, unanticipated, or inappropriate commands or command arguments with the NAK (negative acknowledge) response, “%#?”.

The user must constrain command arguments, including numeric ranges, to be valid entries, otherwise unpredictable results may occur.

The only keypad activity recognized by the SteadyView while it is in remote mode is a depression of the Exit key which is maintained for five seconds. At the end of the five second period, the SteadyView executes the equivalent of a “&#X” command followed by a “*#L” command (see the command descriptions for more information) which puts the unit back in Local mode. This function provides an escape route to re-enable local mode should serial communications fail.

4.6 SUMMARY OF COMMANDS - HOST-TO-STEADYVIEW COMMUNICATIONS

1. Supervisory Level Commands

*#B	Comm parameter request
*#L	Enter Local mode
*#M	Enter Remote mode
*#S	Operational status request

2. Run Level Commands

#\$B(+6)	Change comm parameters according to the following six bytes
#\$D(+8)	Display ASCII text contained in the following eight bytes
#\$d	Restore display to normal
#\$E	Send cal weight
#\$G	Send range
#\$H	Send TLS Hi setting
#\$J	Send display language
#\$L	Send TLS low setting
#\$M	Go to Menu mode
#\$O(+3)	Send analog output value
#\$R	Reset TLS alarm
#\$T	Send tension
#\$U	Send units
#\$V(+3)	Set analog output value
#\$W	Send web width

3. Menu Level Commands

&#c	Go to CAL Prompt
&#C	Begin CAL sequence
&#D(+1)	Set SteadyView address to the number in the subsequent byte and store it in EEPROM
&#E(+6)	Set cal weight
&#G(+4)	Set range according to the following four bytes
&#H(+4)	Set TLS hi setting according to the following four bytes
&#J(+1)	Set display language according to the next byte
&#K(+1)	Set TLS operating mode according to the next byte
&#L(+4)	Set TLS lo setting according to the following four bytes
&#N	Store new parameters in EEPROM and go to Run mode
&#U(+3)	Set Units according to the following three bytes
&#v(+1)	Set analog output operating mode according to the following byte
&#W(+5)	Set web width according to the following five bytes
&#X	Go to Run mode without storing new parameters
&#y	Go to REZERO Prompt
&#Y	Begin REZERO sequence
&#z	Go to Zero Prompt
&#Z	Begin ZERO sequence

4. Summary of SteadyView-to-Host Responses

%#A	Command receipt acknowledged; command processed correctly
%#B(+7)	Communications status is contained in the next seven bytes
%#C	Calibration sequence complete
%#E(+6)	Cal weight is contained in the next six bytes
%#F	Unable to rezero
%#G(+4)	Range is contained in the next four bytes
%#H(+4)	TLS High setting is contained in the next four bytes
%#J(+1)	Display language code is contained in the next byte
%#L(+4)	TLS Low setting is contained in the next four bytes
%#O(+3)	Analog output value is contained in the next three bytes
%#P	Unable to zero
%#Q	Unable to calibrate
%#S(+7)	Operational status response
%#T(+4)	Tension is contained in the next four bytes
%#U(+3)	Units is contained in the next three bytes
%#W(+5)	Web width is contained in the next five bytes
%#Y	Rezero sequence complete
%#Z	Zero sequence complete
%#?	Command receipt acknowledged; command not processed

4.7 DETAILED DESCRIPTION - SUPERVISORY LEVEL COMMANDS

***#M Enter Remote mode**

Causes the SteadyView to go to Run mode (if it is not already in Run mode); disable local mode; enter remote mode; disable keypad input; and await further commands.

Response: %#A

***#L Enter Local mode**

Causes the SteadyView to disable remote mode and enter local mode.

Response: %#A (if local mode has been entered), %#? (if SteadyView cannot enter local mode).
 SteadyView can only enter local mode if it is in Run mode.

***#B Comm parameter request**

Causes the SteadyView to respond with bytes containing its present communication parameters.

Response: %#B(+6), where the last six bytes are interpreted as follows:

nnnXXX Baud rate, nnn=	003: 300 baud
	012: 1200 baud
	024: 2400 baud
	048: 4800 baud
	096: 9600 baud
XXXnnX Stop bits, nn=	10: 1 stop bit
	15: 1.5 stop bits (special)
	20: 2 stop bits (special)
XXXXXn Parity, n=	N: None
	O: Odd (special)
	E: Even (special)

***#S Operational status request**

Causes the SteadyView to respond with six bytes containing its present operational status.

Response: %#S(+7), where the last seven bytes are interpreted as follows:

nXXXXX Alarm status, n=	I TLS alarm inactive A TLS alarm active
XnXXXX mode status, n=	R Run mode M Menu mode E Edit mode
XXnXXX Comm status, n=	L Local mode R Remote mode
XXXnXX Output status, n=	L Local mode R Remote mode
XXXXnX TLS Status, n=	O TLS Off L TLS Latched mode M TLS Momentary mode
XXXXXn Display status, n=	N Display normal T Display text mode
XXXXXXn Range status, n=	+ Over-range - Under-range N Within range

4.8 DETAILED DESCRIPTION - RUN LEVEL COMMANDS

##M Go to Menu mode

Causes the SteadyView to go into Menu mode, provided SteadyView is not already in Menu mode.

Response: %#A (if the command is processed), %#? (if the command was not processed)

##T Send Tension

Causes the SteadyView to send the most recent tension value, exactly as it would appear on its display.

Response: %#T(+4), where the last four bytes are the ASCII values of the characters appearing on the display, most significant character first. If the displayed characters include a decimal point, then the ASCII value for a decimal point will be sent in that position.

##U Send Units

Causes the SteadyView to send the currently specified measurement unit, exactly as it appears on its display.

Response: %#U(+3), where the last three bytes are the ASCII values of the characters appearing on the display, most significant character first. If the displayed characters include a space, then the ASCII value for a space will be sent in that position.

##G Send Range

Causes the SteadyView to send the currently specified range value, exactly as it would appear on its display.

Response: %#G(+4), where the last four bytes are the ASCII values of the characters which would appear as the range value, most significant character first. If the displayed characters would include a decimal point, then the ASCII value for a decimal point will be sent in that position.

##W Send Web Width

Causes the SteadyView to send the currently specified web width value, exactly as it would appear on its display.

Response: %#W(+5), where the last five bytes are the ASCII values of the characters which would appear as the web width, most significant character first, including the decimal point. The format of this value is "xxx.x", which is the same as it would appear on the indicator's display.

##E Send Cal weight

Causes the SteadyView to send its calibration weight.

Response: **##E(+6)**, where the last six bytes are the ASCII values of the characters which would appear as the calibration weight, most significant character first, including the decimal point. The format of this value is “xxxx.x”, which may contain zeros in positions which would not be shown on the indicator’s display.

##R Reset TLS Alarm

Causes the SteadyView to reset the TLS alarm, if that alarm is set.

Response: **##A** (if alarm was active) **##?** (if the alarm was inactive)

Issuing this command has the same effect as pressing the “TLS RESET” key on the indicator’s front panel. If one of the indicator’s trip points are being exceeded, and its TLS mode is “momentary”, then the reset command will have only a momentary effect.

##L Send TLS Low Setting

Causes the SteadyView to send its current TLS low trip point value.

Response: **##L(+4)**, where the last four bytes are the ASCII values of the characters which would appear as the TLS Low value, most significant character first. If the displayed characters would include a decimal point, then the ASCII value for a decimal point will be sent in that position.

##H Send TLS Hi Setting

Causes the SteadyView to send its current TLS high trip point value.

Response: **##H(+4)**, where the last four bytes are the ASCII values of the characters which would appear as the TLS High value, most significant character first. If the displayed characters would include a decimal point, then the ASCII value for a decimal point will be sent in that position.

##J Send display language

Causes the SteadyView to respond with a code containing its current display language.

Response: **##J**, where the next byte contains the ASCII code for the current display language, to be interpreted as follows:

- 0: Reserved
- 1: English (default)
- 2: German
- 3: Spanish
- 4: French
- 5: Italian
- 6-Z: Reserved

##B(+6) Change comm parameters

Causes the SteadyView to change its communication parameters according to the subsequent six bytes, as follows:

nnnXXXXX Baud rate, nnn=	003: 300	012: 1200	024: 2400
	048: 4800	096: 9600	
XXXnnXXX Stop bits, nn=	10:1 stop bit		
	15:1.5 stop bits (special)	20:2 stop bits (special)	
XXXXXn Parity, nn=	N: None		
	O: Odd (special)		
	E: Even (special)		

Response: **##A** (if command is to be processed)
##? (if command cannot be processed)

Because of the nature of the action of this command, the response must be sent using the existing parameters, while all subsequent communications will be performed with the new settings.

##D(+8) Display ASCII text

Response: **##A** (if the command is processed) **##?** (if the command cannot be processed)

Causes the SteadyView to stop displaying tension and instead display the ASCII text contained in the following 8 bytes. The display will continue to show this message until another message is sent, or until a **##d** command is issued.

##d Restore the display to normal

Causes the SteadyView to revert to its original display, i.e. display of tension.

Response: %#A (if the command is processed) %#? (if the command cannot be processed)

##O Send analog output value

Causes the SteadyView to respond with the value sent to the DAC which produces the current analog output.

Response: %#O(+3), where the three bytes are ASCII representations of the hexadecimal values and are interpreted most significant nibble first, least significant nibble last. Data is arranged such that "FFF" represents maximum DAC output and "000" represents minimum DAC output.

Example: A response of %#O7FF represents the middle of the DAC's output range and would produce a SteadyView output voltage of 0V (in voltage mode) or 0mA (in current mode).

##V(+3) Set analog output value according to the following three bytes (only will be processed when in remote output mode)

Response: %#A (if the command is processed) %#? (if the command cannot be processed)

4.9 DETAILED DESCRIPTION - MENU LEVEL COMMANDS

&#K(+1) Set TLS operating mode according to the next byte:

n TLS mode, n= O TLS off
 L TLS latched alarm
 M TLS momentary alarm

Response: %#A (if the command is processed) %#? (if the command cannot be processed)

&#U(+3) Set units according to the following three bytes, as follows:

nnn Units, nnn =	lb	pounds	oz	ounces
	gm	grams	N	Newtons
	PLI	pounds per lineal inch	ozi	ounces per lineal inch
	gcm	grams per lineal centimeter		
	Ncm	Newtons per lineal centimeter		

Response: %#A (if the command is processed) %#? (if the command cannot be processed)

&#G(+4) Set the range according to the following four bytes

Response: %#A (if the command is processed) %#? (if the command cannot be processed)

&#E(+6) Set calibration weight according to the following six bytes

The calibration weight is specified in the format "xxxx.x", but because the indicator only accepts three digits plus a decimal point, two of the first or the last positions must be zeros.

&#z Go to Zero Prompt

Response: %#A (if the command is processed) %#? (if the command cannot be processed)

Depending on where the indicator is within the menu structure, it may not be possible for it to process this command.

&#Z Begin ZERO sequence

Response: %#? if the command cannot be processed,

%#Z when zeroing is complete, or %#P if unable to zero

Depending on where the indicator is within the menu structure, it may not be possible for it to process this command.

&#c Go to CAL Prompt

Response: %#A (if the command is processed) %#? (if the command cannot be processed)

Depending on where the indicator is within the menu structure, it may not be possible for it to process this command.

&#C Begin CAL sequence

Response: %#? if the command cannot be processed,

%#C when complete, or %#Q if unable to calibrate

Depending on where the indicator is within the menu structure, it may not be possible for it to process this command.

&#y Go to REZERO Prompt

Response: %#A (if the command is processed) %#? (if the command cannot be processed)

Depending on where the indicator is within the menu structure, it may not be possible for it to process this command.

&#Y Begin REZERO sequence

Response: %#? if the command cannot be processed,
%#Y when complete, or %#F if unable to zero

Depending on where the indicator is within the menu structure, it may not be possible for it to process this command.

&#L(+4) Set TLS Lo Setting

Response: %#A (if the command is processed) %#? (if the command cannot be processed)

The TLS LO setting must be appropriate for the specified range value.

&#J(+1) Set display language

Causes SteadyView to change its display language according to the ASCII code in the next byte, to be interpreted as follows:

0: No change

1: English (default)

2: German

3: Spanish

4: French

5: Italian

6-Z: Reserved

Response: %#A (if the command is processed) %#? (if the command cannot be processed)

This command takes effect immediately, but applies only to scrolled prompt and error messages.

&#H(+4) Set TLS Hi Setting

Response: %#A (if the command is processed) %#? (if the command cannot be processed)

The TLS HI setting must be appropriate for the specified range value.

&#D(+1) Set the SteadyView address to number in subsequent byte and store in EEPROM

Response: %#A (if the command is processed) %#? (if the command cannot be processed)

The value contained in the subsequent byte is interpreted as a binary value whose value is between 0 and 255.

&#X Go to Run mode without storing new parameters

Response: %#A (if the command is processed) %#? (if the command cannot be processed)

&#N Store new parameters and go to Run mode

Response: %#A (if the command is processed) %#? (if the command cannot be processed)

##v(+1) Set the analog output operating mode according to the next byte:

n Analog mode, n= R Remote mode: analog output is according to data sent over the serial interface

L Local mode: analog output is proportional to tension

Response: %#A (if the command is processed) %#? (if the command cannot be processed)

SECTION 5

CARE & MAINTENANCE

The SteadyView unit requires very little maintenance. If necessary, clean the overlay on the front panel using a small amount of a gentle solvent like Windex®. Do not use strong petroleum-based solvents - these could damage the panel material. Do not use large amounts of water.

6.1 ERROR MESSAGES ON THE DISPLAY

Error

This message can appear while you are setting up the Tension Limit Switch. For example, if you try to set a low limit which is above the high limit, the SteadyView will not accept the value. The SteadyView will also resist if you try to set a high limit which is above the high end of the range selected for the unit. To recover, set the high or low limit correctly.

Invalid units

This message can appear if you set up the range, then later change the units used by the display (lb, gm, etc.). Generally, if you change the units setting, the other settings will translate to the new units automatically. The “Invalid units” message will appear if this translation would result in a number which would be out of range for the display.

Unable to zero

This message may appear if, during zeroing, the output from the transducers is equal to 95% of the full range of the indicator. (After zeroing, this would only allow the indicator to use 5% of the range.) Before zeroing, be sure the web and any other weights have been removed from the sensor roll. Also be sure the range has been set correctly.

This message can also appear if there is a lot of variation in the signals from the transducers while the SteadyView is trying to zero. This could be caused by some sort of weight or load on the sensor roll, or by a problem with the transducers or connecting cables. If necessary, check for a hardware problem by substituting the transducers and cables. This symptom could also be caused by a faulty power supply for the transducer excitation voltage.

Unable to calibrate

This message may appear if the setting for the calibration point is not logical (below the zero point). During calibration, be sure to set the calibration weight correctly. Attach the weight as shown in Fig. 6.

This message can also appear if there is a lot of variation in the signals from the transducers while the SteadyView is trying to calibrate. This could be caused by a problem with the transducers or connecting cables.

Unable to rezero

This message may appear if, during rezeroing, the output from the transducers is equal to 95% of the full range of the indicator. (After rezeroing, this would only allow the indicator to use 5% of the range.) Before rezeroing, be sure the web and any other weights have been removed from the sensor roll. Also be sure the range has been set correctly.

This message can also appear if there is a large difference between the original zero value and the value determined during rezeroing. This could be caused by a variation in the signals from the transducers while the SteadyView is trying to rezero. Check for an extra weight or load on the sensor roll, or for a problem with the transducers or connecting cables.

If necessary, check for a hardware problem by substituting the transducers and cables. This symptom could also be caused by a faulty power supply for the transducer excitation voltage.

6.2 OTHER ERROR CONDITIONS

Analog output not working correctly

If you have chosen the 0-10V voltage output, and the voltage is not present, check for a short-circuit or very low impedance in the circuit to the remote indicator.

If you have chosen 0-20 mA or 4-20mA current-loop output, and the remote indicator does not go through the full range, check for a very low impedance in the circuit to the remote indicator.

If the SteadyView indication remains at a very high or low value:

One side of the transducer signal may not be reaching the SteadyView. Check the transducer cables and all connections.

If the SteadyView indication remains at a medium value:

The transducers may not be connected. Check the transducer cables and all connections.

If there is no display on the SteadyView:

Check the AC connections to the terminals on the power board of the SteadyView. Check the fuses inside the unit (See Fig. 4 on Page 5). There may also be a problem with the 5V power supply inside the unit.

If the unit does not operate, and the three LED's flash in sequence:

This will happen if the memory for the unit has been erased. You can do this by pressing the Menu, Edit and Exit keys for 5 seconds. The unit will not operate until you re-enter the setup values.

If the Tension Limit Switch is not operating:

Check to be sure the operating mode has been set correctly (momentary or latching). Check that the high and low trip points have been set correctly. The relay for this function may be set up for either normally-open or normally-closed action. Check the terminals on the Power PCB of the SteadyView.

SECTION 7

REPLACEMENT PARTS

7.1 REPLACEMENT PARTS

Tension Meter, analog:	722-1385 (specify scale)
Fuses: 115v = .250A/250V	108-0054
230v = .125A/250V	108-0045
Fuse Covers	108-0005
Power Board	723-1324
Front Board	723-1432
Interconnection Cable	723-1313
Instruction Manual	801-0706 R1

This section is intended for experienced technicians who want to set up the unit with a minimum of advice. For more detailed set-up instructions, see Section 3.

Note - If you want to set up the unit for operation using a foreign language, see Section 3.6.

1. COLLECT INFORMATION ABOUT YOUR APPLICATION

Decide on these values before you start:

- Units used for the display (ounces, grams, etc.)
- Highest value you will want the unit to display
- Web width
- Weight used for calibration

2. QUICK PROGRAMMING INSTRUCTIONS

STEP 1 - Choose the units used for measurement

- Turn power switch on.
- Optional - Erase all values by pressing Menu, Edit and Exit keys at the same time. The three LEDs will light in sequence.
- Unit menu will show:

UNIT lb

- Press Edit to choose correct units:

lb	pounds	total across whole width of web
oz	ounces	total across whole width of web
gm	grams	total across whole width of web
Kg	kilograms	total across web
N	Newtons	total across whole width of web
ozi	ounces	per inch of web width
PLI	pounds	per inch of web width
K/M	kilograms	per meter width
Ncm	Newtons	per centimeter of web width
gcm	grams	per centimeter of web width
- Press Exit to save.
- Press Menu to move on.

STEP 2 - Set the upper end of the indicated range

This value should be about 25% higher than any normal reading.

- Go to the Range menu:

RNG 0000
- Press Edit to change the first digit.
- Press Menu to move to the next digit.
- Use Edit to change this digit, if necessary.
- Repeat for other digits.
- When finished, press Exit.
- Press Menu to move on.

STEP 3 - Set the web width

(Only if you selected measurement by ozi, pli, Mcm, K/M, or gcm)

- Go to the Web Width menu:
IN 000.0
- Make the setting using Edit to change, Menu to go to next digit.
- When finished, press Exit.
- Press Menu to move on.

STEP 4 - Zero the system

- Go to the Zeroing menu:
ZERO?
- Press the Edit button:
Remove weight and press EDIT
- Remove the web from the sensing roll.
- Press Edit again.
- Press Menu when the menu says:
ZEROED

STEP 5 - Enter the calibration weight

- Go to the Calibration Weight menu:
WT xxxx
Use a weight which is 50% to 90% of the full range value.
- Make the setting using Edit to change, Menu to go to next digit.
- When finished, press Exit.
- Press Menu to move on.

STEP 6 - Do the calibration

- Go to the Calibration menu:
CAL?
- Press Edit to continue:
Apply weight & press EDIT
- Hang the test weight from the sensor roll. Thread a length of rope over the center of the roll. Be sure to follow the exact path of the web. The rope must extend from the roll *before* the sensing roll to the roll *after* it. See Fig. 8.
- Once the weight is on the sensing roll, press Edit.
- When the process is finished, press Menu to move on.

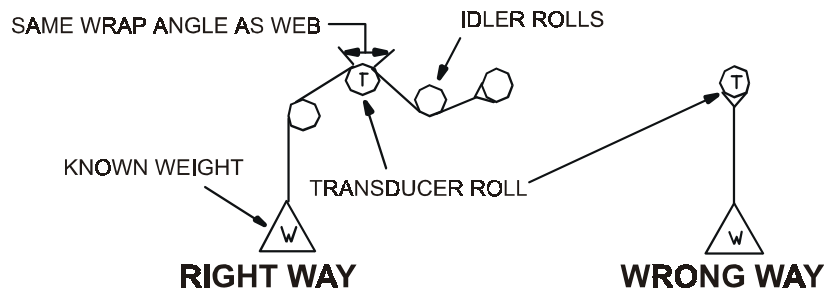

Figure 8 - WEB PATH

STEP 7 - Re-zero

- Go to the Rezeroing menu:
REZERO?
- Press Edit:
Remove weight and press EDIT
- Remove the weight and rope, then press Edit.
- When menu says *Rezeroed*, either press Menu to continue set-up, or press Exit twice then Menu to leave set-up and measure tension.

STEP 8 - Set up the tension limit switch

- Go to the TLS Set-Up menu:
TLS OFF
- If the TLS is off, to skip this item, press Menu. Go to Step 11.
To set up the TLS, press Edit.
- Press Edit to get the function you want:

TLS OFF	<i>Off</i>
TLS MOM	<i>Momentary on, resets automatically</i>
TLS LTCH	<i>Latches, must be reset using the TLS Reset button</i>
- When finished, press Exit.
- Press Menu to move on.

STEP 9 - Set the low limit for the tension limit switch

- Go to the Low Limit menu:
LO xxxx
- Make the setting using Edit to change, Menu to go to next digit.
- When finished, press Exit.
- Press Menu to move on.

STEP 10 - Set the high limit for the tension limit switch

- Go to the High Limit menu:
HI xxxx
- Make the setting using Edit to change, Menu to go to next digit.
- When finished, press Exit.

STEP 11 - Set the address for the serial interface

- Go to the Address menu:
ADDR 0
- To prepare to change the address, press Edit.
- Press Edit again to change the value. (Do not use address 0 for any SteadyView units if more than one will be connected to the system.)
* When finished, press Exit.

STEP 12 - Save the settings

- Press Exit again to get the Store or Abort message. Press Menu to store the settings, Edit to go back and make changes, or Exit to leave without making changes.

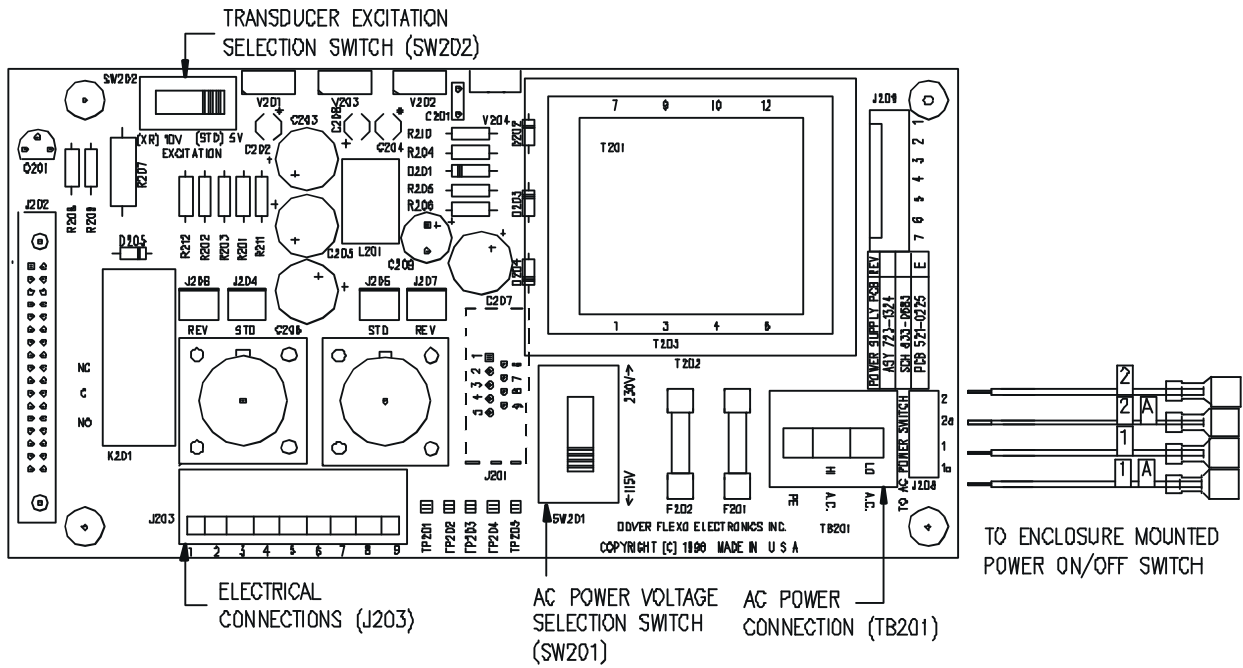

Figure 9 - POWER BOARD

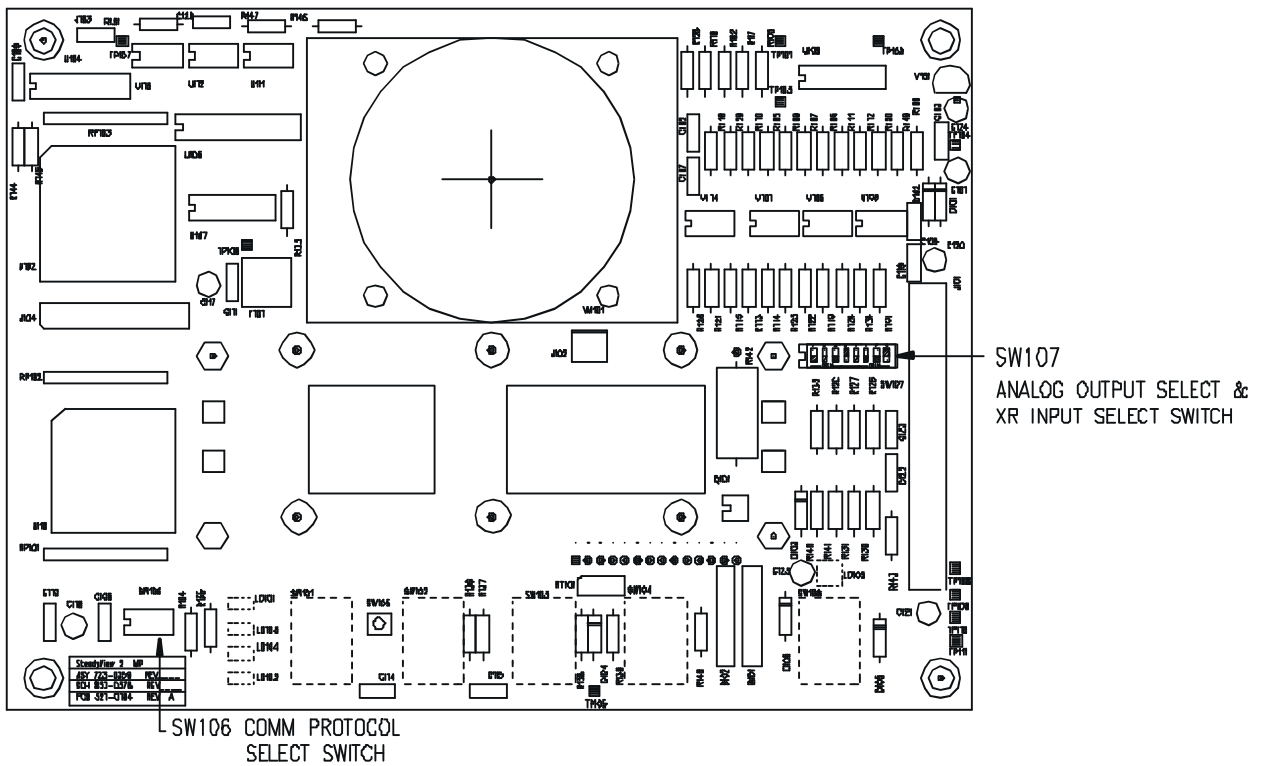

Figure 10 - FRONT BOARD

MODELS C, RS AND UPB TRANSDUCERS

THE TENSION (T) AND COMPRESSION (C) STRAIN GAGES ARE CONNECTED IN A BRIDGE CONFIGURATION. AS THE BEAMS BEND SLIGHTLY UNDER WEB TENSION, THE GAGE RESISTANCES CHANGE PRODUCING AN OUTPUT SIGNAL WHICH IS DIRECTLY PROPORTIONAL TO THE WEB TENSION.

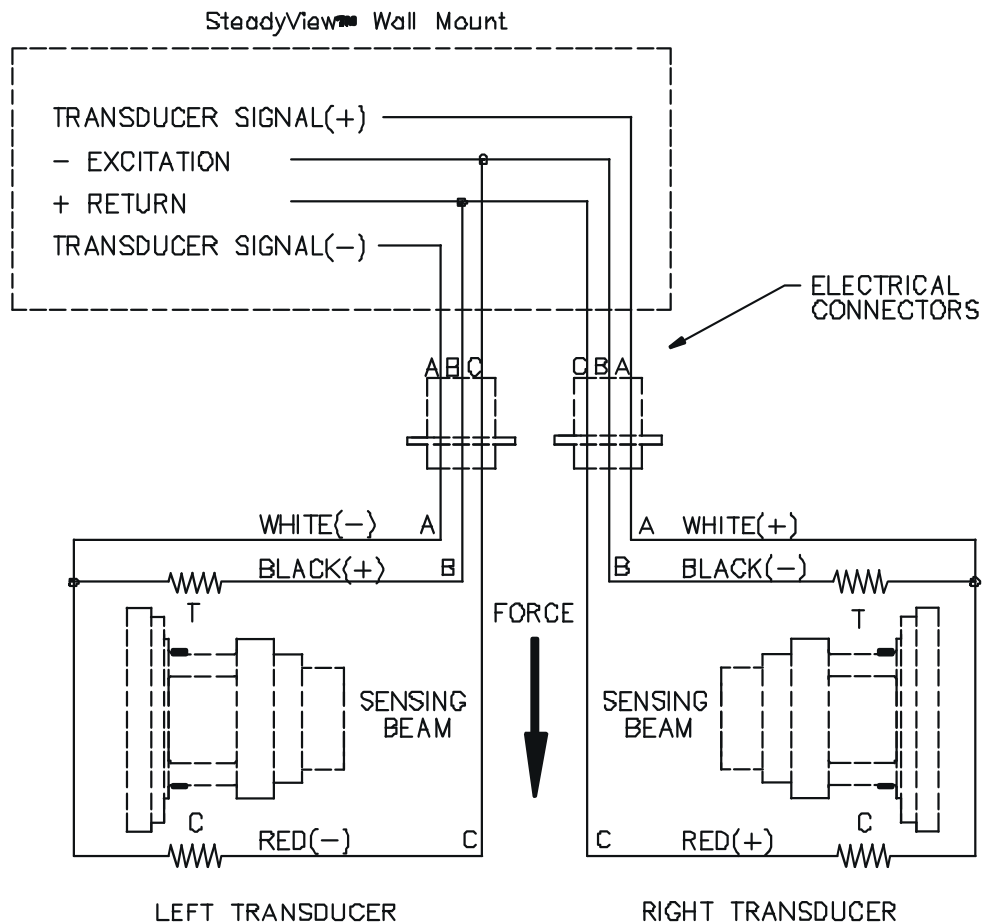

Figure 11 - MODEL C, RS, & UPB TRANSDUCER WIRING

RIBBON FILAMENT (RF) TRANSDUCERS

THE TENSION (T) AND COMPRESSION (C) STRAIN GAGES ARE CONNECTED IN A BRIDGE CONFIGURATION. AS THE BEAMS BEND SLIGHTLY UNDER WEB TENSION, THE GAGE RESISTANCES CHANGE PRODUCING AN OUTPUT SIGNAL WHICH IS DIRECTLY PROPORTIONAL TO THE WEB TENSION.

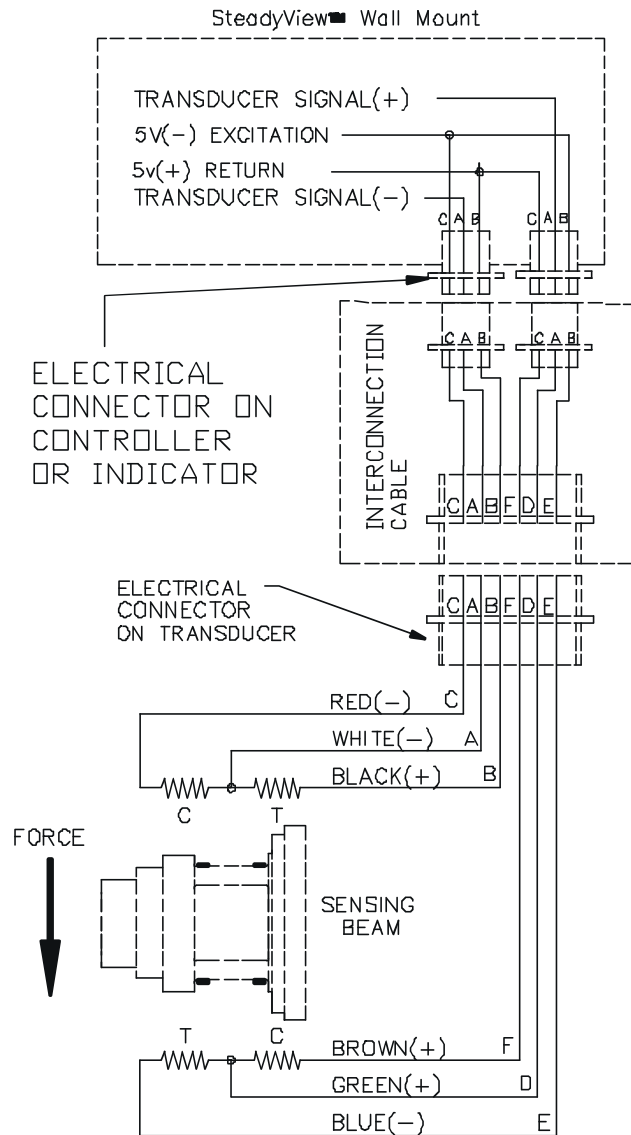

Figure 12 - RF TRANSDUCER WIRING

TENSION ROLL (TR) AND NARROW WEB (NW) TRANSDUCERS

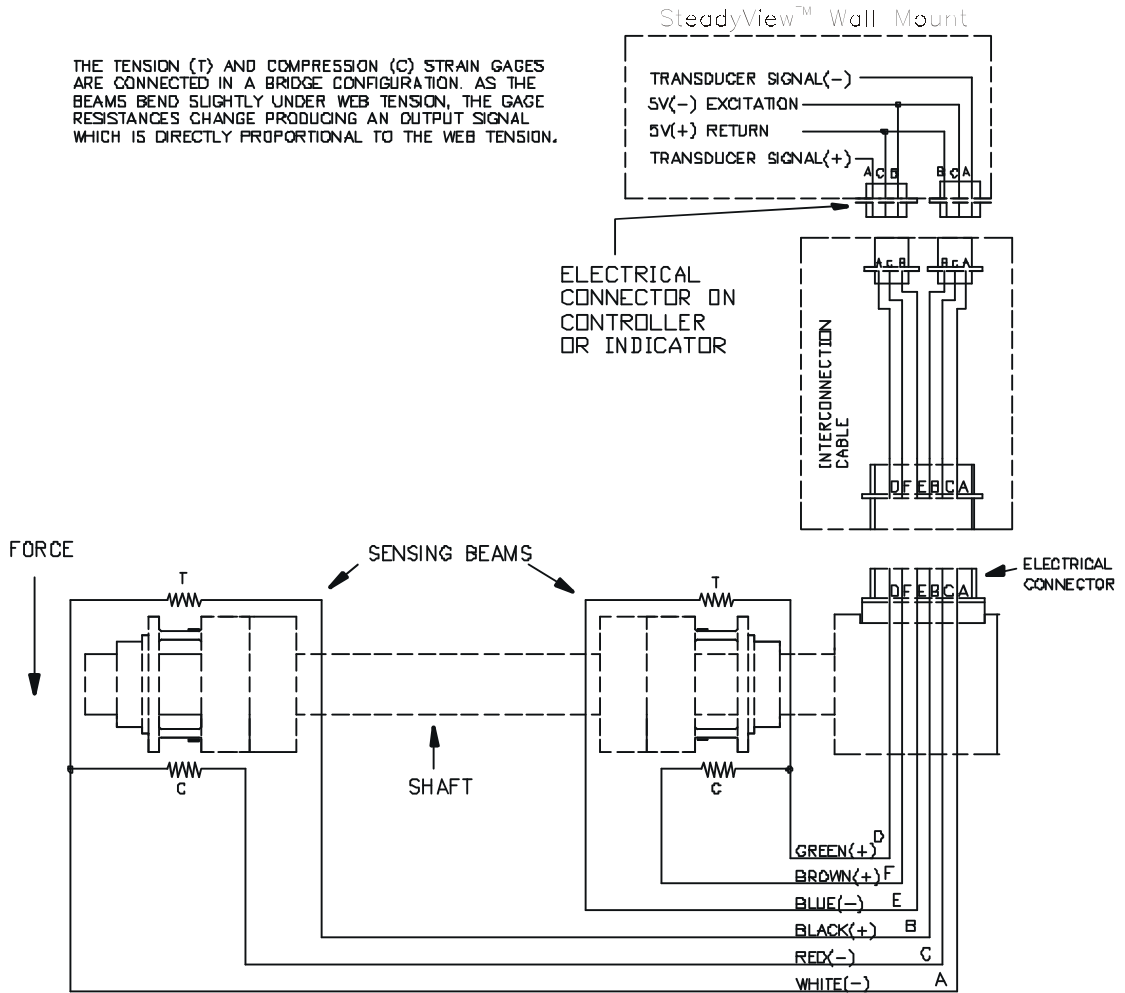

Figure 13 - TR & NW TRANSDUCER WIRING

LOW TENSION (LT) TRANSDUCERS

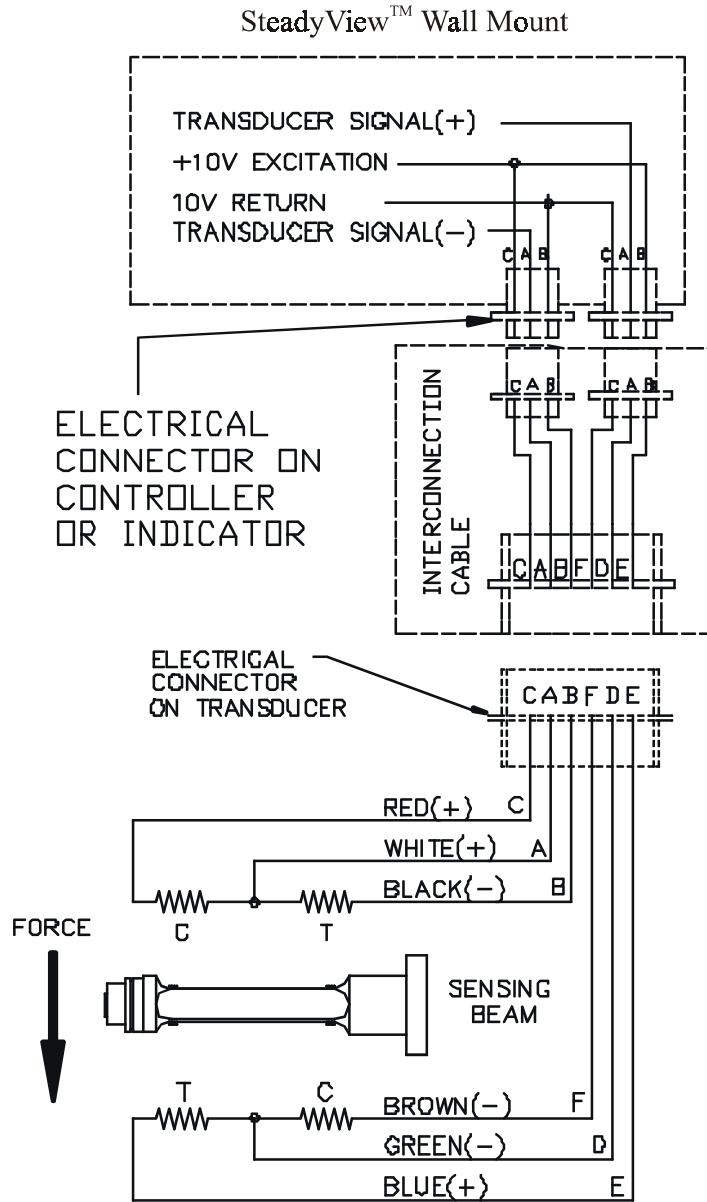

Figure 14 - LT TRANSDUCER WIRING

TYPICAL TENSIONS FOR WEB MATERIALS

ACETATE		.5 lb. per mil per inch of width	
FOIL	Aluminum	.5 lb. per mil per inch of width	
	Copper	.5 lb. "	
CELLOPHANE		.75 lb. per mil per inch of width	
NYLON		.25 lb. per mil per inch of width	
PAPER	15 lb *	.4 lb. per inch of width	
	20 lb	.5 lb.	"
	30 lb	.75 lb.	"
	40 lb	1.25 lb.	"
	60 lb	2.0 lb.	"
	80 lb	3.0 lb.	"
	100 lb	4.0 lb.	"
* based on 3000 sq. ft. ream			
PAPERBOARD	8pt	3.0 lb. per inch of width	
	12pt	4.0 lb.	"
	15pt	4.5 lb.	"
	20pt	5.5 lb.	"
	25pt	6.5 lb.	"
	30pt	8.0 lb.	"
POLYETHYLENE		.12 lb. per mil per inch of width	
POLYESTER (Mylar)		.75 lb. per mil per inch of width	
POLYPROPYLENE		.25 lb. per mil per inch of width	
POLYSTYRENE		1.0 lb. per mil per inch of width	
RUBBER	<u>GAUGE</u>	<u>AT 25% STRETCH</u>	<u>AT 50% STRETCH</u>
	10 mil	1.75	3.68
	12 mil	1.10	2.03
	16.5 mil	4.09	8.17
	26 mil	2.47	4.97
SARAN		.15 lb per mil per inch of width	
STEEL	<u>GAUGE - INS</u>	<u>UNWIND-PSI</u>	<u>REWIND-PSI</u>
	.001 -.005	1000	4000
	.006 -.025	850	3500
	.026 -.040	750	3000
	.041 -.055	650	2600
	.058 -.070	550	2200
	.071 -.090	450	1800
	.091 -.120	450	1400
	.121 -.140	400	1200
	.141 -.165	400	1000
	.166 -.200	400	900
	.201 -.275	400	800
.276 -.380	300	700	
VINYL		.05 lb.per mil per inch of width	

*** For laminated webs, sum the tension for the individual webs and add 0.1 lb per inch of width.

TERMS AND CONDITIONS OF SALE AND SHIPMENT

1. THE COMPANY

Dover Flexo Electronics, Inc. is hereinafter referred to as the Company.

2. CONFLICTING OR MODIFYING TERMS

No modification of, additions to or conflicting provisions to these terms and conditions of sale and shipment, whether oral or written, incorporated into Buyer's order or other communications are binding upon the Company unless specifically agreed to by the Company in writing and signed by an officer of the Company. Failure of the Company to object to such additions, conflicts or modifications shall not be construed as a waiver of these terms and conditions nor an acceptance of any such provisions.

3. GOVERNING LAW

This contract shall be governed by and construed according to the laws of the state of New Hampshire, U.S.A. The parties agree that any and all legal proceedings pursuant to this contract shall take place under the jurisdiction of the courts of the State of New Hampshire in the judicial district of Strafford County.

4. PENALTY CLAUSES

Penalty clauses of any kind contained in orders, agreements or any other type of communication are not binding on the Company unless agreed to by an officer of the Company in writing.

5. WARRANTY

Dover Flexo Electronics, Inc. warrants its' products to be free of defects in material and workmanship for five years from date of original shipment. During the warranty period the Company will repair or replace defective products free of charge if such products are returned with all shipping charges prepaid and if, upon examination, the product is shown to be defective. This warranty shall not apply to products damaged by abuse, neglect, accident, modification, alteration or mis-use. All repairs and replacements under the provisions of this warranty shall be made at Dover Flexo Electronics or at an authorized repair facility. The Company shall not be liable for expenses incurred to repair or replace defective products at any other location or by unauthorized persons or agents. This warranty contains all of the obligations and warranties of the Company. There are no other warranties, either expressed or implied. No warranty is given regarding merchantability or suitability for any particular purpose. The Company shall not be liable in either equity or law for consequential damages, losses or expenses incurred by use of or inability to use its' products or for claims arising from same. No warranty is given for products of other manufacturers even though the Company may provide these products with its' own or by themselves. The provisions of this warranty can not be changed in any way by any agent or employee of the Company. Notice of defects must be received within the warranty period or the warranty is void.

6. PAYMENTS

Standard terms of credit are net 30 days from date of shipment, providing satisfactory credit is established with the Company. Amounts past due are subject to a service charge of 1.5% per month or portion thereof or 18% per annum. The Company reserves the right to submit any unpaid late invoices to a third party for collection and Buyer shall pay all reasonable costs of such collection in addition to the invoice amount. All quoted prices and payments shall be in U.S. Dollars.

If the Company judges that the financial condition or payment practices of the Buyer does not justify shipment under the standard terms or the terms originally specified, the Company may require full or partial payment in advance or upon delivery. The Company reserves the right to make collection on any terms approved in writing by the Company's Finance Department. Each shipment shall be considered a separate and independent transaction and payment therefore shall be made accordingly. If the work covered by the purchase order is delayed by the Buyer,

upon demand by Company payments shall be made on the purchase price based upon percentage of completion.

7. TAXES

Any tax, duty, custom, fee or any other charge of any nature whatsoever imposed by any governmental authority on or measured by any transaction between the Company and the Buyer shall be paid by the Buyer in addition to the prices quoted or invoiced.

8. RETURNS

Written authorization must be obtained from the Company's factory before returning any material for which the Buyer expects credit, exchange, or repairs under the Warranty. Returned material (except exchanges or repairs under the Warranty) shall be subject to a minimum re-stocking charge of 15%. Non-standard material or other material provided specially to the Buyer's specification shall not be returnable for any reason. All material returned, for whatever reason, shall be sent with all freight charges prepaid by the Buyer.

9. SHIPPING METHOD AND CHARGES

All prices quoted are F.O.B. the Company's factory. The Company shall select the freight carrier, method and routing. Shipping charges are prepaid and added to the invoice of Buyers with approved credit, however the Company reserves the right to ship freight-collect if it prefers. Shipping charges will include a charge for packaging. Company will pay standard ground freight charges for items being returned to Buyer which are repaired or replaced under the Warranty.

10. CANCELLATION, CHANGES, RESCHEDULING

Buyer shall reimburse Company for costs incurred for any item on order with the Company which is cancelled by the Buyer. Costs shall be determined by common and accepted accounting practices.

A one-time hold on any item ordered from the Company shall be allowed for a maximum of 30 days. After 30 days, or upon notice of a second hold, Company shall have the right to cancel the order and issue the appropriate cancellation charges which shall be paid by Buyer. Items held for the Buyer shall be at the risk and expense of the Buyer unless otherwise agreed upon in writing. Company reserves the right to dispose of cancelled material as it sees fit without any obligation to Buyer.

If Buyer makes, or causes to make, any change to an order the Company reserves the right to change the price accordingly.

11. PRICES

Prices published in price lists, catalogs or elsewhere are subject to change without notice and without obligation. Written quoted prices are valid for thirty days only.

12. EXPORT SHIPMENTS

Payment for shipments to countries other than the U.S.A. and Canada or to authorized distributors shall be secured by cash in advance or an irrevocable credit instrument approved by an officer of the Company. An additional charge of 10% will apply to any letter of credit. There will be an extra charge for packaging and documentation.

13. CONDITION OF EQUIPMENT

Buyer shall keep products in good repair and shall be responsible for same until the full purchase price has been paid.

14. OWNERSHIP

Products sold are to remain the property of the Company until full payment of the purchase price is made.

1/25/99

INDEX

0 - 20 mA signal output	3	Menus, listing of	8
0-10V signal output	3	Mounting the Unit	4
4 - 20 mA signal output	3		
AC Connections	5	Operator Controls	2
Accessories	3	Options	3
Address, serial interface, setting	12		
Baud rate	16	Parity bits	16
Calibration	7, 10	Power Cord	5
weight, specifying	10	Power LED	1
Care and Maintenance	23	Programming	8
Commands			
Host to SteadyView	17	Quick Setup	27
Menu Level	21		
Run Level	19	Range, setting	9
Supervisory	18	Replacement Parts	26
Types and Communications	16	Rezeroing	10
Data bits	16	RS232 serial interface	15
Dimensions	4	RS485 serial interface	15
Disassembly	7	Run LED	1
		Run mode	2
Edit key	2		
Electrical Connections	5	Settings, saving	12
English	12	Signal Output Connections	13
Erase all values	7,14,27	Spanish language	12
Error	24	Specifications	3
Exit key	2	Stop bits	16
Extended range	3, 13	Store or Abort mode	2, 7
Features	3		
Foreign language operation	12	Tension Limit Switch	2, 14, 25
French language	12	high limit	11
Front Panel	1	latching	11
		low limit	11
German language	12	setting	11
		Tension, reading	1
Invalid units	24	TLS Reset LED	1
Installation Instructions	4	Transducer cables	6
Italian language	12	Transducer Excitation Voltage	3, 13
		Troubleshooting	24
Menu key	2		
Menu mode	2, 8	Units, list of	8
		Web width, setting	9
		Zeroing the system	9

**217 PICKERING ROAD
ROCHESTER, NEW HAMPSHIRE 03867-4630 U.S.A
TEL: (603) 332-6150
FAX: (603) 332-3758
E-MAIL: info@dfc.com INTERNET: www.dfc.com**

CANADA

MEXICO

UNITED KINGDOM

EUROPE

TAIWAN

KOREA

AUSTRALIA

COLOMBIA

INDIA