



THE TENSION CONTROL SPECIALISTS

# INSTRUCTION MANUAL



## STEADYWEB 6™ Digital Tension Controller

DOC 801-0004

**Dover Flexo Electronics**  
**307 Pickering Road**  
**Rochester, NH 03867-4630**  
**U.S.A.**

**FOR ASSISTANCE:**

**TECHNICAL SERVICE** - Installations, Start-Up, Troubleshooting, Repairs, Field Service or Returns. **Call us (603) 332-6150 and ask for Technical Support or email us at: [techsupport@dfc.com](mailto:techsupport@dfc.com)**

**CUSTOMER SERVICE** - Replacement Parts, Individual Products, Questions about Orders, Manuals. **Call (603) 332-6150 and ask for Customer Service or email us at: [customerservice@dfc.com](mailto:customerservice@dfc.com)**

**SALES** - Product Information, Systems Application Questions, or Placing Orders, **Please e-mail us at: [sales@dfc.com](mailto:sales@dfc.com) or call (603) 332-6150 and ask for Sales.**

Telephone: (603) 332-6150      Fax: (603) 332-3758

E-mail: [info@dfc.com](mailto:info@dfc.com)      Internet: [www.dfc.com](http://www.dfc.com)

## SAFETY



### This label indicates: “Read The Manual”

Please read this manual prior to installing and operating the controller. Take care to follow local codes and only allow properly trained individuals to operate or service the equipment. Failure to follow the manual's instructions and practice safe working habits could result in property damage, personal injury and/or death.

Email: [techsupport@dfc.com](mailto:techsupport@dfc.com)

Telephone: (603) 332-6150

- **Observe all warning labels.**
- **Never remove warning labels.**



**WARNING:** Before servicing the SteadyWeb 6™, power should be removed from the device. Failure to do so could result in property damage, personal injury and/or death.

### \*\*\* OPERATION \*\*\*

Once your SteadyWeb 6™ controller has been installed and setup, you should only need to use the following sections for day-to-day operation:

Section 1 - Main Interface Overview

Section 2 - Operating Instructions

### \*\*\* INSTALLATION AND SETUP \*\*\*

Your SteadyWeb 6™ Controller has been properly configured at our factory. To install it and start it up, it should only be necessary to use these sections of this manual:

Section 4 - Installation

Section 6 - Calibration

Section 8 - Tuning Adjustments

## ***About This Revised Manual***

This document is a consolidation of the **OPERATING INSTRUCTIONS MANUAL** (801-2539) and the **TECHNICAL REFERENCE MANUAL** (801-2540).

The **OPERATING INSTRUCTIONS MANUAL** is contained in sections 1-2.

The **TECHNICAL REFERENCE MANUAL** is contained in sections 3-11.

## TABLE OF CONTENTS

---

<b>DOCUMENT CONVENTIONS .....</b>	<b>8</b>
<b>1 USER INTERFACE OVERVIEW .....</b>	<b>9</b>
1.1 MAIN INTERFACE DESCRIPTION .....	9
1.2 DISPLAY MODE DESCRIPTIONS .....	11
1.3 MENU MODE AND NAVIGATION .....	12
<b>2 OPERATING INSTRUCTION .....</b>	<b>13</b>
2.1 BASIC OPERATION .....	13
2.2 DISPLAY ADJUSTMENTS .....	13
2.3 SAVING, RECALLING AND DELETING SETUPS .....	14
2.4 AUTO TENSION SETPOINT AND MANUAL OUTPUT SETTING .....	15
2.5 TAPER TENSION .....	16
2.6 TLS, ALARMS AND RESETTING THEM .....	17
2.7 RESETTING DIAMETER ALARM .....	18
<b>3 PRODUCT DESCRIPTION .....</b>	<b>19</b>
3.1 GENERAL DESCRIPTION .....	19
3.2 TENSION ZONES .....	20
3.3 VERSIONS OF THE CONTROLLER .....	21
<b>4 INSTALLATION .....</b>	<b>28</b>
4.1 DIMENSIONS inches (mm) .....	28
4.2 SAFETY AND EMC REQUIREMENTS .....	31
4.3 INSTALLATION INSTRUCTIONS .....	33
4.4 TRANSDUCER VOLTAGE SELECTION .....	34
4.5 CONTROL OUTPUT SELECTION .....	34
4.6 TENSION OUTPUT SELECTION .....	35
4.7 EMERGENCY STOP CONFIGURATION .....	36
4.8 CUSTOMER +10/15V OUTPUT SELECTION .....	37
4.9 POWER ELECTRICAL CONNECTIONS .....	38
4.10 STANDARD ELECTRICAL CONNECTIONS .....	39
<b>5 USER INTERFACE OVERVIEW .....</b>	<b>47</b>
5.1 MAIN INTERFACE DESCRIPTION .....	47
5.2 DISPLAY MODE DESCRIPTIONS .....	47
5.3 MENU DISPLAY MODE AND NAVIGATION .....	48
5.4 PID TUNE VIEW .....	49

<b>6</b>	<b>CALIBRATION</b> .....	<b>51</b>
6.1	TENSION CALIBRATION .....	51
6.2	REMOTE TENSION AMPLIFIER CONFIGURATION .....	54
6.3	LINE/ROLL SPEED INPUT CALIBRATION .....	54
6.4	DC TACHOMETER CALIBRATION .....	56
6.5	PULSE TACHOMETER CALIBRATION.....	57
6.6	DIAMETER INPUT CALIBRATION .....	59
6.7	SIGNAL FILTERING .....	60
<b>7</b>	<b>SETUP</b> .....	<b>62</b>
7.1	CONTROL FEEDBACK MODES .....	62
7.2	UNWIND ZONE SETUP .....	63
7.3	INTERMEDIATE ZONE SETUP.....	63
7.4	REWIND ZONE SETUP.....	64
7.5	SOFT START SETUP.....	65
7.6	SAMPLE AND HOLD / RATIO SETUP .....	67
7.7	TENSION LIMIT SWITCH SETUP .....	68
7.8	DIAMETER ALARM SETUP .....	69
7.9	INPUTS SETUP.....	69
7.10	RELAY OPTION SETUP (Included in TLS option) .....	71
7.11	COMMUNICATION OPTIONS SETUP .....	71
7.12	TENSION ON RELAY OPTION .....	71
7.13	POWER ON SETTINGS .....	72
7.14	ANTI-TAMPER/SECURITY LOCKOUT.....	72
<b>8</b>	<b>TUNING ADJUSTMENTS</b> .....	<b>73</b>
8.1	PID CONTROL TUNING.....	73
8.2	TUNING PROCEDURE .....	73
8.3	TUNING EXAMPLES.....	74
8.4	ADVANCED TUNING ADJUSTMENTS .....	76
8.5	DIAMETER COMPENSATION.....	76
8.6	ACCELERATION COMPENSATION .....	77
<b>9</b>	<b>OPERATING INSTRUCTIONS</b> .....	<b>78</b>
9.1	BASIC OPERATION.....	78
9.2	DISPLAY ADJUSTMENTS .....	78
9.3	SAVING, RECALLING AND DELETING SETUPS.....	78
9.4	SETTING AUTO AND MANUAL SETPOINTS .....	78

9.5	USING TAPER .....	78
9.6	TLS ALARMS, DIAMETER ALARM AND RESETTING THEM.....	78
9.7	ZEROING TENSION.....	78
<b>10</b>	<b>CARE AND MAINTENANCE.....</b>	<b>79</b>
<b>11</b>	<b>TROUBLESHOOTING GUIDE .....</b>	<b>80</b>
11.1	GENERAL TROUBLESHOOTING TIPS .....	80
11.2	ERROR MESSAGES.....	80
11.3	DIAGNOSTIC SCREENS .....	83
	<b>APPENDIX A: LOCATIONS OF JUMPERS AND ADJUSTMENTS .....</b>	<b>85</b>
	<b>APPENDIX B: MENU HIERARCHY .....</b>	<b>86</b>
	<b>APPENDIX C: ELECTRICAL CONNECTIONS .....</b>	<b>87</b>
	<b>APPENDIX D: TRANSDUCER ELECTRICAL CONNECTIONS.....</b>	<b>89</b>
	<b>APPENDIX E: TYPICAL TENSION FOR VARIOUS MATERIALS .....</b>	<b>91</b>
	<b>APPENDIX F: ENVIRONMENTAL TERMS .....</b>	<b>92</b>
	<b>LIST OF ILLUSTRATIONS.....</b>	<b>93</b>

# DOCUMENT CONVENTIONS

---

**NOTICE** **NOTES** - Highlight important concepts, decisions you must make, or the implications of those decisions.



**CAUTIONS** - Tell you when equipment may be damaged if the procedure is not followed properly.



**WARNINGS** - Tell you when people may be injured, or equipment may be damaged if the procedure is not followed properly.

Numbered lists indicate tasks that should be carried out in sequence:

1. First do this
2. Then do this

Bulleted lists are used for:

- Tasks that can be carried out in any order
- Itemized information



# 1 USER INTERFACE OVERVIEW

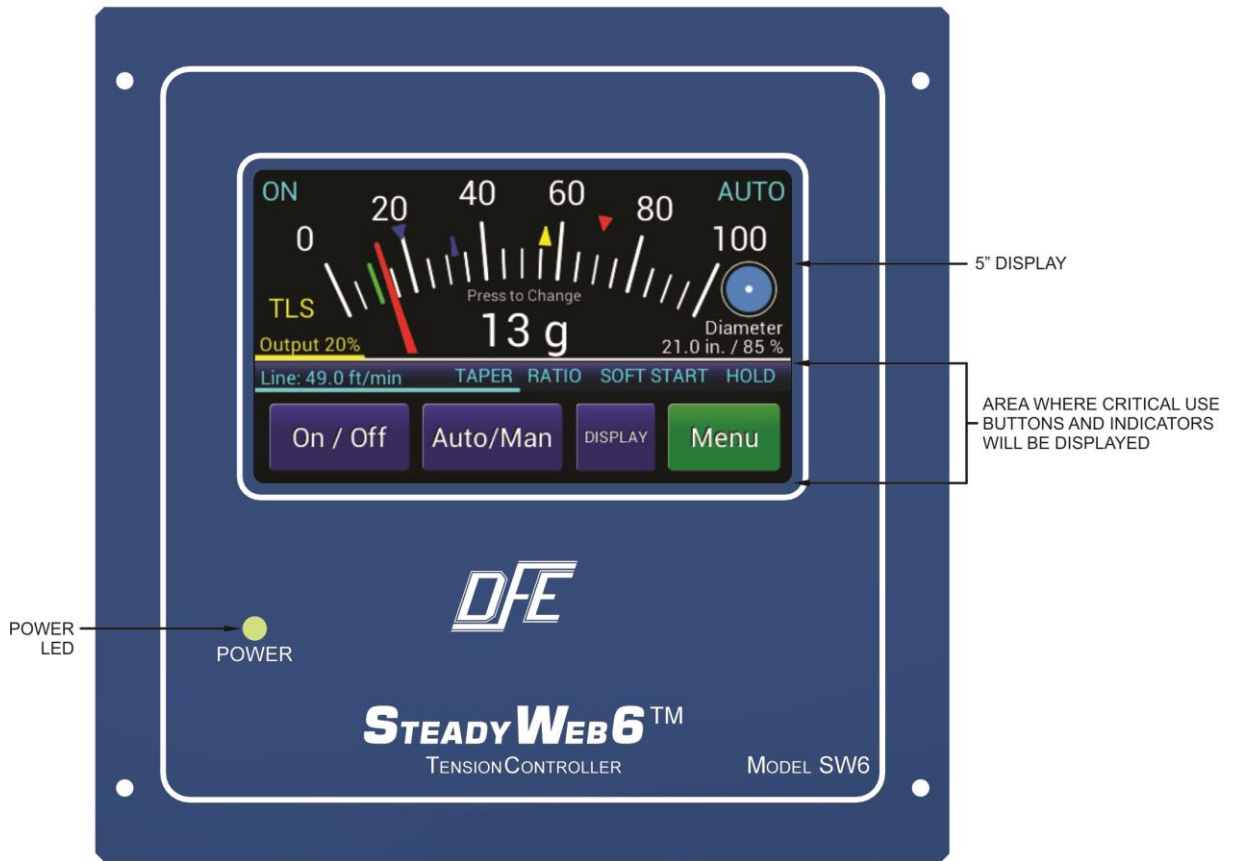


Figure 1-1 - STEADYWEB 6™ USER INTERFACE

## 1.1 MAIN INTERFACE DESCRIPTION

The SteadyWeb 6™ accepts all instructions and displays all information via a 5" touchscreen display (Fig. 1-1). All controller functions are context driven and operate with color-coded buttons on the display. There are no mechanical knobs, switches or buttons to operate.

For ease of use, the locations of the critical-use buttons/critical-awareness indicators have been made uniform from one screen to the next. Those uniformly located buttons / indicators (Fig. 1-2) include the following:

1. Tension **On/Off**, **Auto/Man** (Manual), and **Display** toggle buttons (all colored blue and at the bottom of the screen). The only time the On / Off toggle button displays as anything other than On/Off is when the controller is placed in E-STOP by an external input. When in E-STOP, the On / Off button displays as **E-STOP**, and may only be restored by clearing the E-STOP signal, external to the controller. There are no functions within the controller which will permit over-riding an external E-Stop signal.
2. **Line Speed**, **Taper**, **Ratio**, **Soft Start** and **Hold** (Sample & Hold) mode status indicators on the information line above the toggle buttons, when active.
3. **TLS** indicator and **Roll Diameter** indicator, left and right of the tension display, above the information line, when applicable.
4. Tension **On/Off** Status (upper LH corner) and **Man/Auto** Status (upper RH corner).



**Figure 1-2 - LOCATIONS OF TOGGLE BUTTONS / INDICATORS IN DISPLAY**

All screens, settings and adjustments which are not primarily tension-displaying functions require some on-screen navigation to access them.

The remaining button in the lower right-hand corner of the screen is green and displays as either “Menu”, “Back” or “Save” depending on what screen is current, and is used to advance to other menus, to back out of menus, or to save selections or adjustments.



**Figure 1-3 – SCREEN SHOWING SIDE ARROWS**

Green buttons on menu screens indicate selectable functions. When there are more buttons in a menu than fit on the menu screen, the excess buttons are off-screen, but the menu screen may be shifted to reveal them by pressing arrow buttons at one or both ends of the screen (Fig. 1-3). If there are no arrows at the end of the screen, then there are no off-screen buttons to reveal.

Holding a green button down will bring up related information, which effectively serves as an on-screen manual.

Grey buttons indicate functions that may not be selected until certain conditions are met. If in doubt about why a button is grey, it may be pressed and held to view the explanation. Sometimes meeting the necessary conditions requires permission-based access and actions in accordance with the Technical Reference Section of this manual.

On navigation screens, pressing the Back button will return the prior screen. If the Back button has been replaced with another function, the use of which is not desired, the screen may be exited via the Display button instead.

In the unlikely event of a screen failure, an always-on Power LED (Fig. 1-1) on the front of the controller will inform the operator if the unit is still powered up.

## 1.2 DISPLAY MODE DESCRIPTIONS

To display the tension setpoint, real time tension and related process information, the Tension Display mode should be used when making product, and the Menu Display mode should generally be used when making changes to the process. When in Tension Display mode, pressing the Menu button will switch to the Menu Display mode. Likewise, when in Menu Display mode, pressing the Display button will return the screen to Tension Display mode.

**TENSION DISPLAY MODES:** Two different screens are available in Tension Display mode. Tension can either be displayed as a momentary value on an analog meter (Fig. 1-4) or as tension vs. time in a trend-line plot (Fig. 1-5) and may be toggled back and forth by pressing the Display toggle button.

Operator-adjustable display settings include **Tension Update Time, Display Damping, Plot Update Time, Line Speed Display, Diameter Display** and **Display Brightness**, the adjustments of which are described in Section 2.2, DISPLAY ADJUSTMENTS.

- 1. Analog Meter** - The analog meter displays tension with a bold needle sweeping across similarly bold divisions in the form of a traditional analog meter and is the default display (Fig. 1-4). The meter scale is determined by the full range tension value. This easily read analog meter is further enhanced by a large digital tension readout in the center of the screen and expresses the measured tension in white characters. The auto tension setpoint is indicated by a yellow caret atop the smaller divisions of the analog meter.

The controller output, when tension control is on, is indicated as a percentage of full output to the left of the meter scale, above the On/Off button. When tension control is off, this indicated as the manual setpoint instead.



**Figure 1-4 – ANALOG METER DISPLAY**



**Figure 1-5 – TREND LINE GRAPH DISPLAY**

When Taper is active, a blue caret, also found atop the smaller divisions of the meter scale indicates the dynamic tension setpoint.

When TLS Low and / or TLS High are active, those limits are indicated by blue and red carets respectively, atop the larger divisions of the meter scale. For more details about TLS, see Section 2.6, TLS ALARMS AND RESETTING THEM.

- 2. Trend-line Graph** - An alternative to the analog meter, the tension trend-line graph (Fig. 1-5) plots both the tension and the controller output versus time, from right to left. Since the plots of tension and controller output can cross or overlap each other, the controller output is plotted as a line, and the area below the tension plot is filled in, with both sets of data plotted in contrasting colors for improved clarity. The plots of the tension and output are keyed to a legend in the left margin and the auto tension setpoint is identified by a yellow caret in the right margin of the trend-line graph. If Taper is active, and auto tension control is on, the dynamic tension setpoint is indicated by a AT@ moving in the right-hand margin of the display.

The time it takes for the trend-line to cross the screen is the **Line Graph Update Time**, and is selectable as 30 seconds or 1, 2, 5, 10 or 30 minutes, per Section 2.2, DISPLAY ADJUSTMENTS. The greater durations allow for a greater data sample, but with a loss of resolution.

The trend-line may also be paused by holding down the Display button until the trend-line stops moving across the screen. Plotting will resume when the Display button is pressed again. Tension data for the paused period will not be recorded and may not be retrieved.

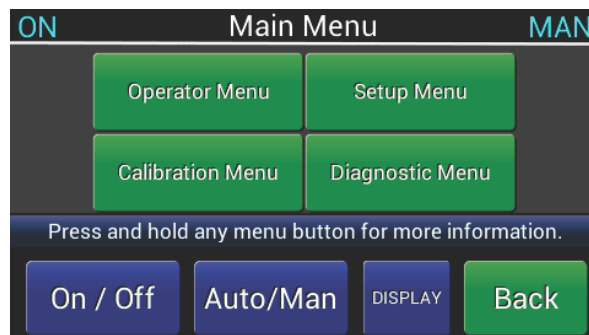
When TLS is used, neither TLS Low nor TLS High Limits will be indicated on the Trend-line graph. If either tension limit switch is tripped however, the on-screen alarms will still be issued, and must be cleared according to Section 2.6, TLS, ALARMS AND RESETTING THEM.

This trend-line graph display also appears repeatedly in the Technical Reference Section of this manual on PID Tune View displays which allow for real-time P, I, and D adjustments while viewing the controller output and tension.

### 1.3 MENU MODE AND NAVIGATION

From either of the tension display screens, the Menu button will deliver the operator to the Main Menu (Fig. 1-6) where subordinate menus appear for further navigation. Note that the names of all menu screens are consistently displayed at the center of the top line.

1. **OPERATOR MENU** - Under the Operator Menu, the following choices are available:
  1. **Display Configuration** - Tension Update, Display Damping, Plot Update Time, Line Speed Display, Diameter Display & Display Brightness (See Section 2.2, DISPLAY ADJUSTMENTS for more detail).
  2. **Configure Taper** - Taper Enable & Taper Percentage (See Section 2.5, TAPER TENSION for more detail).
  3. **Store / Delete Setup** - Store Setup & Delete Setup (See Sections 2.3.1, and 2.3.3 for more detail).
  4. **Recall Setup** - As many as 30 user-named setups (See Section 2.3.2 for more detail).
  
2. **DIAGNOSTIC MENU** - Under the Diagnostic Menu, the following choices are available (All are Read Only, and are useful for discussions with DFE Tech Support), with all other choices greyed out:
  - Version Menu** - Displays versions and revisions of the software and hardware
  - Read Digital Inputs** - Displays digital input signals
  - Read Analog Inputs > Transducer** - Displays analog input signals from the transducers
  - Read Analog Inputs > Signal Inputs** - Displays analog input signals from other than the transducers
  
3. **SETUP MENU and CALIBRATION MENU** - Both require permission-based access and actions in accordance with the Technical Reference Section of this manual.



**Figure 1-6 - MAIN MENU**

## 2 OPERATING INSTRUCTIONS

### 2.1 BASIC OPERATION

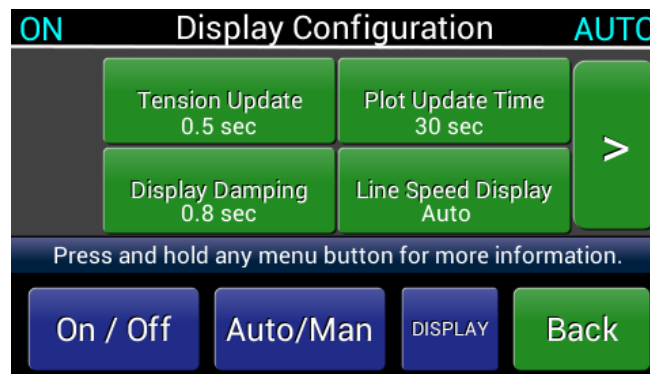
When the controller has been properly set up and the control loop has been tuned, it should maintain constant tension while the machine is running and while speed, roll diameter, or other conditions change. However, during startup of a new roll you may want to change modes, setpoint or other settings. Usually, the only thing the operator will need to do is turn tension On or Off, toggle between Auto and Manual modes, and change the Auto tension setpoint or Manual output setting.

With tension off, to turn tension on and enable output, press the tension On / Off button. If the controller is in Auto mode, the output will ramp up or down to tension the web to the Auto Tension Setpoint. If the controller is in Manual mode, the output will change to the manual output setting. Either the auto or manual mode will be indicated as active by the Auto / Man status indicator in the upper right-hand corner of the display. The Auto and Manual modes can be toggled back and forth by pressing the Auto / Man button.

While in either auto or manual mode, the A+@ and A-A buttons for adjusting the auto tension setpoint or the manual output setting can be brought up by touching the tension display screen.

### 2.2 DISPLAY ADJUSTMENTS

Operator-adjustable display settings described below may be found and adjusted at *Menu > Main Menu > Operator Menu > Display Configuration* (Fig. 2-1). Adjustments to these settings may be made using the up and down arrows, and then saved by pressing the SAVE button. These adjustments serve visual purposes only, and do not affect the control loop.



**Figure 1-7 – DISPLAY CONFIGURATION MENU**

**Tension Update** - Choose 0.2, 0.5, 1.0, 2.0 or 5.0 seconds and press SAVE to adjust the time it takes for the display to update with new information. Longer updates produce fewer changes in displayed information over time, at the expense of rapid visual response to changes in tension.

**Display Damping** - Choose 0.0, 0.2, 0.4, 0.8, 1.6 or 3.2 sec and press SAVE to adjust how smoothly information is displayed.

**Plot Update Time** - Choose 30 sec or 1, 2, 5, 10 or 30 min and press SAVE to adjust time that tension displays before dropping off the trend-line graph screen. This also applies to the PID tune screen referenced repeatedly in the Technical Reference Section of this manual.

**Line Speed Display** - Choose Auto, On or Off and press SAVE. When in Auto, if line speed is required for control, it will be displayed by default. Otherwise, either On or Off may be chosen to force the display of line speed or to suppress it.

**Diameter Display** - Choose Auto, On or Off and press SAVE. When in Auto, if the roll diameter is required for control, it will be displayed by default. Otherwise, either On or Off may be chosen to force the display of roll diameter or to suppress it.

**Display Brightness** - Adjust between 10% and 100% and press SAVE to control the brightness of the display.

## 2.3 SAVING, RECALLING AND DELETING SETUPS

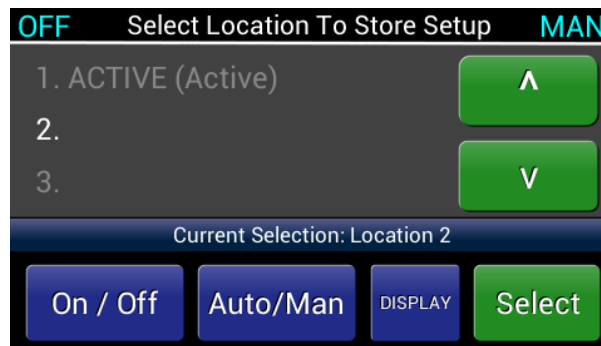
An **Active Setup** is composed of all the most recently selected settings and is held in non-volatile memory, meaning that even if power is lost, the settings will not be. The active setup is not recalled using the named setups, but will automatically come up again upon restart if the controller is shut down while operating in that setup.

A **Saved Setup** is a group of settings saved together in a named setup, and is also preserved in non-volatile memory. Only by saving a named setup after changing one or more settings in that named setup (overwriting), or by deleting the named setup, can saved settings be lost. The SteadyWeb 6™ controller is limited to 30 named setups.

Setups are saved, recalled or deleted through the *Operator Menu > Store / Delete Setup* and the *Operator Menu > Recall Setup* menus, as described below:

**1. Store Setup** - Select Store Setup, then scroll to the location in which to store the setup and press the Select button (Fig. 2-2).

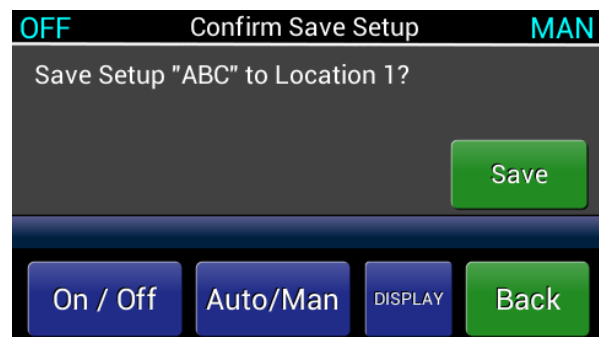
If overwriting an existing setup, the existing name will show up on the information line, and may be accepted as-is. New names must be entered with the keypad (Fig. 2-3). Once the setup name is assigned, and the OK button is pressed, the screen will advance to confirm the saved setup with a press of the Save button (Fig. 2-4) and return to another screen indicating the setup was saved. OK must be pressed to exit.



**Figure 2-2 – SELECT LOCATION TO STORE**

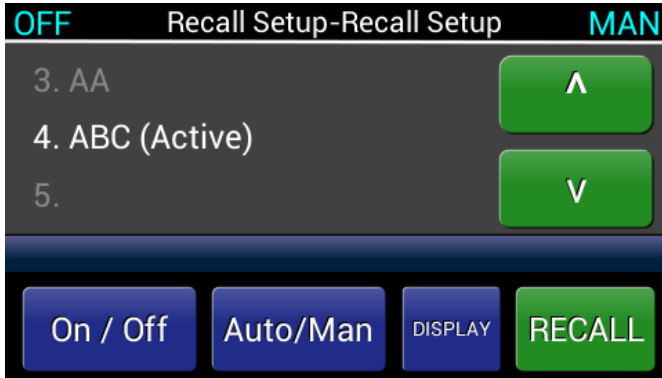


**Figure 2-3 – NAME SETUP SCREEN**

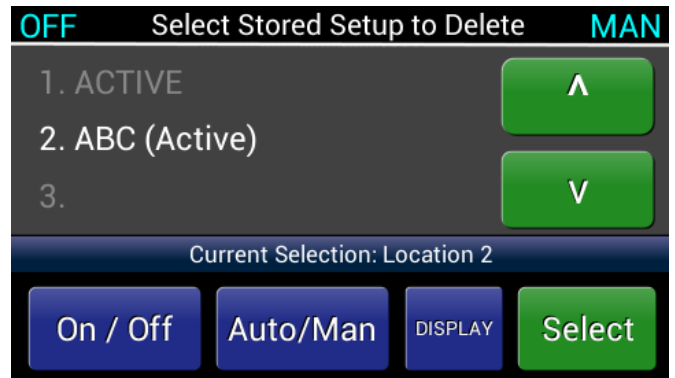


**Figure 2-4 – CONFIRM SAVE SETUP**

2. **Recall Setup** - Scroll to the named setup to be recalled (Fig. 2-5) and press the Recall button. Press Recall in the next screen to copy the selected setup as the active setup. The controller will return another screen indicating that the selected setup was recalled. OK must be pressed to exit.
3. **Delete Setup** - Select Delete Setup, then scroll to the named setup to be deleted and press the Select button (Fig. 2-6). The controller will return another screen indicating that the selected setup was deleted. OK must be pressed to exit.



**Figure 2-5 – RECALL SETUP**



**Figure 2-6 – SELECT SETUP TO DELETE**

## 2.4 AUTO TENSION SETPOINT AND MANUAL OUTPUT SETTING

Pressing or tapping the tension display area on either the Analog Meter or Trend-line Graph display will bring up A+@ and A-A buttons (Fig. 2-7), which are used to adjust the auto tension setpoint by pressing or holding them down. Buttons used to adjust numerical values are velocity sensitive, meaning that the longer the button is depressed, the faster values change.



**Figure 2-7 – ADJUSTING SETPOINT**

Setpoint adjustments made in this manner apply only to the mode displayed on screen at the time. In other words, if the A+@ and A-A buttons are used in the Auto mode, no change is made to the Manual output, and vice versa.

When adjusting the auto tension setpoint with the A+@ and A-A buttons in either the Analog Meter or Trend-line Graph display, the actual tension in white characters is temporarily replaced with the auto tension setpoint in yellow characters. When the A+@ and A-A buttons fade away, the auto tension setpoint in yellow characters disappears and the tension in white characters returns.

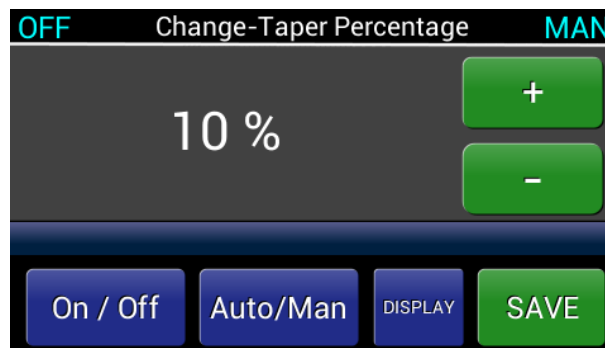
## 2.5 TAPER TENSION

In some cases where poor roll quality might result from winding the entire roll at constant tension, certain types of roll quality problems can be avoided by reducing the tension as the diameter of the roll increases from the core. This reduction is known as **Taper**, and may be enabled at *Menu > Main Menu > Operator Menu > Configure Taper > Taper Enable* (Fig. 2-8). Because the tension setpoint is constantly changing in this case, a new control target has been established, called the Dynamic Tension Setpoint.



**Figure 2-8 – ENABLE TAPER TENSION**

The dynamic tension setpoint is the auto tension setpoint, linearly reduced by the **Taper Percentage**, going from core diameter to full roll diameter. For example, with an auto tension setpoint of 50 lbs, and the taper percentage set at 20%, the dynamic tension setpoint will be 50 lbs at core, and decrease linearly to  $(100\% - 20\%) \times 50 \text{ lbs} = 40 \text{ lbs}$  at full roll.

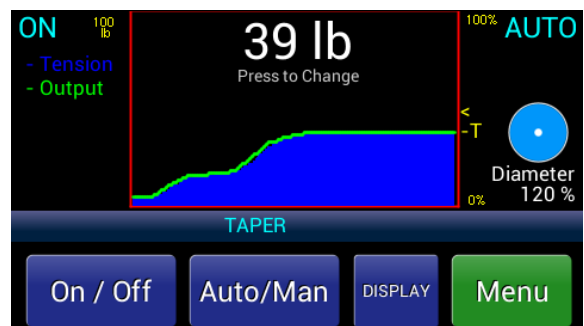


**Figure 2-9 – SET TAPER PERCENTAGE**

The taper percentage may be adjusted at *Menu > Main Menu > Operator Menu > Configure Taper > Taper Percentage* (Fig. 2-9). The dynamic tension setpoint is identified on the momentary tension display with a blue caret above the short meter divisions (Fig. 2-10), and on the trend-line plot as a line plot with an adjacent AT@ (Fig. 2-11) which moves up or down in the RH margin as the roll diameter changes.



**Figure 2-10 – TAPER SETPOINT ON METER**



**Figure 2-11 – TAPER DISPLAY ON TRENDLINE**



Finding the right taper percentage for a particular process may take some experimentation in adjusting both the auto tension setpoint and the taper percentage. See the table below for common winding defects and corresponding corrective actions:

Location	Tight/Loose	Example	Move
Core	Tight	Blocking, Crushed Core	Decrease Tension
Core	Loose	Telescope During Unwinding	Increase Tension
Outside	Tight	Baggy Lane Due to Gage Variation	Increase Tension
Outside	Loose	Out-of-Round Roll	Decrease Tension
Global	Tight	Telescope During Winding, Starring	Increase Tension and Taper

Roisum, David R. What is the Best Taper to Run on My Winder? Converting Magazine, ©November 2007.

**Figure 2-12 - EXAMPLES OF WHEN TO RUN TAPER**

## 2.6 TLS, ALARMS AND RESETTING THEM

Tension Limit Switches (TLS) are used to indicate that tension is outside a specified range. The controller can be set up to respond several different ways when tension wanders outside the range specified with TLS settings.

If TLS is set in the Momentary mode, the controller will issue a visual on-screen "TLS" alarm in yellow letters to the left of the meter scale (Fig. 2-13) when tension is outside of the acceptable range. Once tension has returned to the specified range, the alarm will automatically reset and disappear.

Perhaps more useful is the Latched mode, when the same alarm appears accompanied by a more prominent "RESET TLS" message flashing in red across the meter scale (Fig. 2-14). The latched alarm may be reset only by pressing on the flashing red message, and only after tension has returned to the specified range.

In addition to issuing visual alarms when tension is out of range, TLS can also be set to disable tension control. If tension control is disabled by TLS, the controller cannot be relied upon to return tension to the specified range all by itself. To restore tension to the specified range, press and hold the tension On / Off button until tension returns to the specified range, and then release the button.



**Figure 2-13 – TLS SETPOINT SHOWN**



**Figure 2-14 – RESET TLS SCREEN**

## 2.7 RESETTING DIAMETER ALARM

The diameter alarm alerts the operator that the roll has reached a size requiring attention. A flashing red message to ARESET DA@ appears on screen when the diameter alarm is triggered (Fig 2-15), either by the roll exceeding the Maximum Diameter Trip Point or dropping below the Minimum Diameter Trip Point for longer than the Diameter Alarm Delay setting.

The alarm will persist until reset by manually pressing the flashing red message on the screen, even if the roll diameter returns to the acceptable range. If the diameter alarm is reset while the roll diameter is still outside the acceptable range, it will not trigger again until after the roll diameter has returned to the acceptable range, and again crosses the trip point.



**Figure 2-15 – RESETTING DIAMETER ALARM**

# TECHNICAL REFERENCE

## 3 PRODUCT DESCRIPTION

### 3.1 GENERAL DESCRIPTION

The SteadyWeb 6™ is a digital tension controller designed to automatically maintain tension of any continuous material at a value selected by the equipment operator. The controller combines ease of use with powerful control features and capability that allow for effortless configuration and utilization over a wide variety of tension control applications.

The SteadyWeb 6™ can be powered by 24 VDC or with a built-in 100-240 VAC power supply and is available in panel mount and enclosure mount configurations. The controller is offered in multiple output versions. The user interface features a context-sensitive 5" touch screen display. Illustrated prompts and color graphics make set up easy and allow for a short operator learning curve.

Basic functions of the controller are divided into three components: amplifier, tension regulator and output converter.

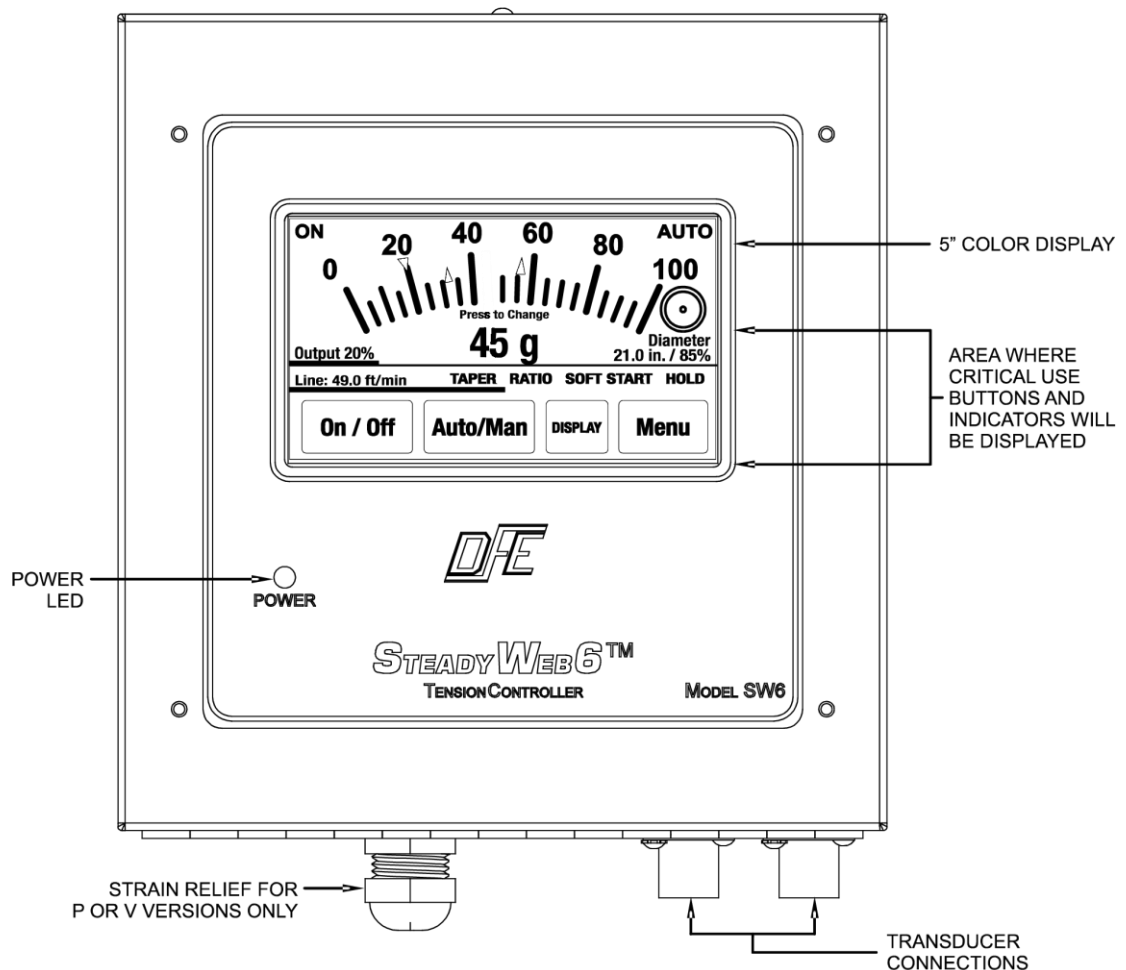


Figure 3-1 - FRONT VIEW OF SteadyWeb 6™

1. **Amplifier** - The first component is a tension amplifier, which supports all Dover Flexo Electronics tension transducers (the transducers measure the actual web tension). It includes a regulated power supply to excite the transducers and circuitry to amplify and measure the transducer output signal. Intelligent excitation circuitry provides automatic excitation voltage selection and monitors for transducer wiring errors or fault conditions, such as a short circuit or open circuit conditions.
2. **Tension Regulator** - The second component is the tension regulator. The controller compares the measured tension to the Auto setpoint value and adjusts an output signal to equalize the measured and desired tension. The regulator function is performed by software and may be influenced by other signal inputs, such as web speed and roll diameter, as dictated by operator-adjustable settings. Regulation is achieved with a PID (Proportional, Integral, Derivative) based control loop with advanced capabilities such as roll diameter compensation and web acceleration compensation.
3. **Output Converter** - The third component is the output stage, the signal from which is used to actuate a brake, clutch, or variable speed DC or AC drive which in turn creates the actual web tension. The output stage is available in several application-dependent versions. Standard in every controller is an isolated control output (adjustable range within the limits of  $\pm 10$  Volts or 4-20 mA). Optionally, a 0-24 VDC output stage may be included internal to the controller to drive 24V devices drawing up to 2.5A. Higher current 0-24V devices may draw customer supplied power through the controller's terminals. Optional external output modules are available to drive higher voltage electrical devices with 0 – 45/90 VDC @ 5 Amps and pneumatic devices with 2 – 75 psi.



**WARNING:** The isolated output is designed to prevent ground loops and noise. It is not intended or approved for safety isolation of hazardous voltages. Do not install unit where the isolated circuit and chassis ground are more than 40Vpk differential.



**WARNING:** AC versions of the SteadyWeb 6™ controller are designed for single phase AC operation only. To prevent product damage and potential hazard, do not connect them across three phase lines or three phase circuits.

## 3.2 TENSION ZONES

Tension zones are created by driven or braked nip rolls, drag bars, braked unwind, driven unwind, or rewind shafts, or anything else that can increase or decrease web tension. One of these elements is at each end of every tension zone.

Many machines that process a continuous web have more than one tension zone. The SteadyWeb 6™ controller can be used in all tension zones, when properly configured for the zone it will be used in. See Figure 3-2 for examples of tension zones.

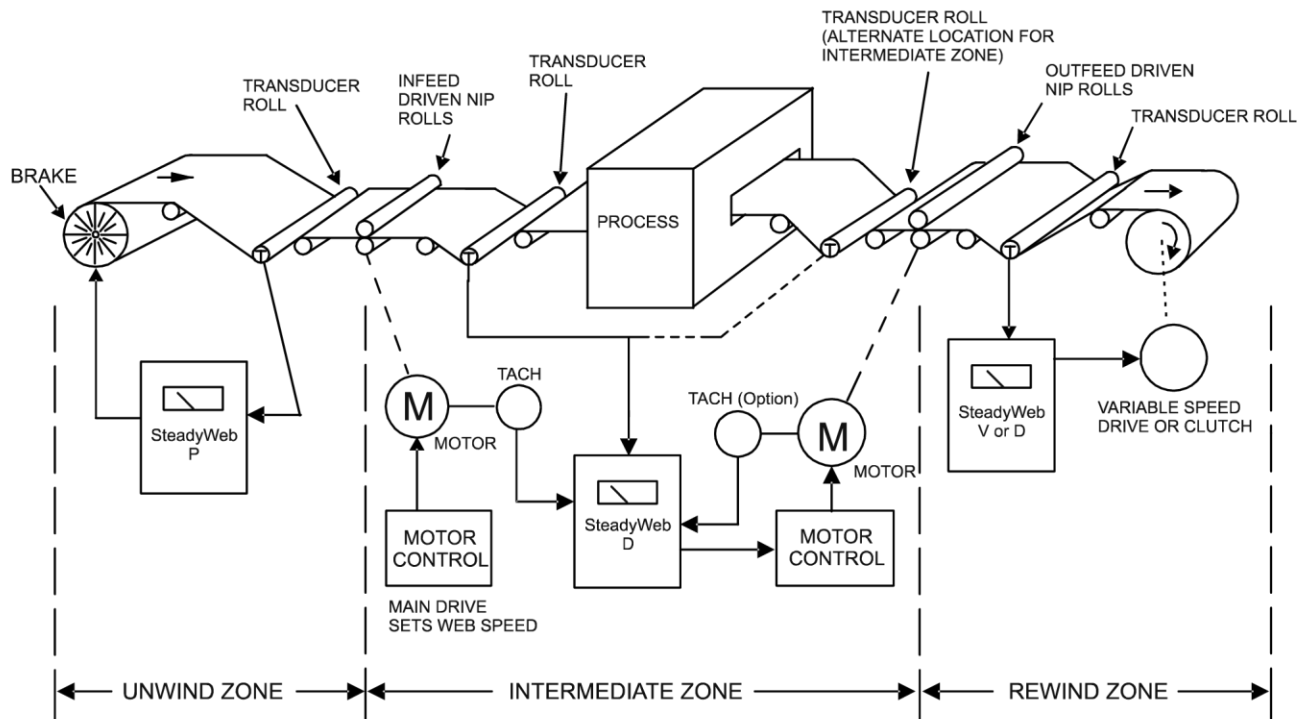


Figure 3-2 - EXAMPLES OF TENSION ZONES

### 3.3 VERSIONS OF THE CONTROLLER

The SteadyWeb 6™ controller is available in multiple output, mounting and power configurations as described below.

1. **OUTPUT** The SteadyWeb 6™ is available with one of three outputs:

**Standard Isolated Output (D).** The standard D version is used to control DC drives or other variable speed drive systems. It offers a jumper-selectable voltage or current output. The voltage output is from 0 to +/-10 VDC, or a user-adjustable range within that window, such as 0 to 10VDC, 0 to +/-5VDC, etc. The current output uses an industry standard 4 to 20mA signal. The control output is isolated from chassis and transducer ground.



**WARNING:** The isolated output is designed to prevent ground loops and noise. It is not intended or approved for safety isolation of hazardous voltages. Do not install unit where the isolated circuit and chassis ground are more than 40Vpk differential.

**Pneumatic Output (P).** The P version is used to actuate any air operated brake or clutch. It includes a servo valve, air filter and pressure regulator installed in a separate enclosure which is fed a 4-20mA signal from the D version of the controller (as described above). The pneumatic output range is 1 to 75 psi (0.07 bar to 5.17 bar).

**High Voltage Output (V).** Embedded within the SW6 Controller is a standard 24V output stage to drive 24V brakes and clutches up to 2.5A drawn current. Devices drawing more than 2.5A at 24V can be accommodated with guidance from DFE Engineering. To operate brakes or clutches at more than 24V, including eddy current clutches, the 45 and 90 V-Out options are available in an outboard module which is fed a 0-10V signal from the D version of the controller (described above) and employs a

Silicon Controlled Rectifier (SCR) to deliver variable voltage of up to 90 VDC. The 24 VDC output is not available with the 230 VAC input.

2. **MOUNTING** The controller is available in two mounting configurations.  
**Open Mount (O).** The open (panel) mount version can be mounted directly into a cabinet or enclosure cutout.  
**Enclosure Mount (E).** The enclosed version can be mounted against any surface strong enough to reliably support the controller.
3. **POWER** The controller is available in two power versions.  
**24 VDC (24).** The DC version is powered from a 24 VDC +/-10% supply.  
**AC (AC).** The AC version includes a universal AC power supply, which can be powered from a 100-240VAC, 50-60Hz supply.



**WARNING:** AC versions of the SteadyWeb 6™ controller are designed for single phase AC operation only. To prevent product damage and potential hazard, do not connect them across three phase lines or three phase circuits.

## 3.4 SPECIFICATIONS

### Power Input:

#### DC:

- 24 VDC +/-10% , 0.6 Amps Typical, 2.2 Amps Internal Fusing (resetting thermal fuse)

#### Optional AC Supply:

- 100-240 VAC +/-10%, 50-60Hz single phase
- 2.2 Amps @ 115 VAC Typical
- 1.2 Amps @ 230 VAC Typical
- Inrush Current 40A @ 230 VAC (cold start)

### Control Output:

#### Version D

- 0 to +/-10 VDC OR 4-20mA (jumper-selectable), both isolated from input power and transducer circuitry
- 0 to +/-10 VDC max loading is 5mA. This requires a 2000 Ohm or greater input resistance for equipment connected to this output
- 4-20mA max loop resistance is 500 Ohms.

### Transducer Signal Input:

- 500mV at rated load per pair of STD transducers
- 1,000mV at rated load per pair of XR transducers

### Customer 10/15VDC Supply:

- 10/15 VDC (jumper-selectable), 100mA max load.

### Transducer Excitation:

- 5 VDC for STD transducers, 10 VDC for XR transducers (automatically software set per sensed transducer resistance, or manually fixed through user configuration settings)
- 35mA per half bridge (70mA total) software short circuit protection
- Duration of excitation short-circuit: Infinite

### Tension Output:

#### All Versions

- 0 to +10 VDC OR 0 to 1mA (jumper-selectable)
- 0 to +10 VDC max loading is 5mA. This requires a 2000 Ohm or greater input resistance for equipment connected to this output.

- 0 to +10 VDC and 0 to 1mA signal capable of under-range and over-range, -14% to 120% of full scale
- (-1.4 VDC to 12 VDC / -0.14mA to 1.2mA), to indicate over-range or error conditions
- 0 to 1mA meter output designed for 50 Ohm impedance meter.

**Digital Inputs:**

- Soft Start, Hold, Ratio, Remote Tension On, Remote Tension Off, Remote Auto, Remote Manual
- Activated by contact with power ground (falling edge)
- Internal weak pull-up resistors to 3.3 VDC
- Max 24 VDC input protection

**Digital Outputs:**

- 3.3V digital diameter alarm output

**Analog Signal Inputs:**

- Line Speed, Roll Speed, Diameter, Remote Auto Setpoint, Remote Manual Setpoint, RTA1, RTA2
- Designed for 0-10 VDC input signal, 0-12 VDC range sense capability
- Max 24 VDC input protection

**Tension Precision:**

- Max error of 1% over temperature range. 0.1% Typical

**Zero (Tare) Range:**

- Minimum 95% of transducer rating

**Calibration Range:**

- 50:1 max

**Control Loop Time:**

- Less than 5mSec

**Transducer Tension Analog to Digital Converter (ADC) Resolution:**

- 16-Bit at 242Hz sample rate
- 20.62 $\mu$ V Resolution with 5V Excitation (STD Transducers)
- 41.24 $\mu$ V Resolution with 10V Excitation (XR Transducers)

**Analog Signals\* Analog to Digital Converter (ADC) Resolution:**

- (Line Speed, Roll Speed, Diameter, Remote Auto Setpoint, Remote Manual Setpoint, RTA1, RTA2)
- 12-Bit at 242Hz sample rate
- 2.93mV Resolution

**Control Output Digital to Analog Converter (DAC) Resolution (D Version):**

- 12-Bit at 242Hz update rate.
- -10 VDC to 10 VDC Out: 6.0mV Resolution
- 4-20mA Out: 9.6 $\mu$ A Resolution

**Tension Output Digital to Analog Converter (DAC) Resolution:**

- 12-Bit at 242Hz update rate.
- 0-10VDC Out: 3.3mV Resolution
- 0-1mA Out: 0.33 $\mu$ A Resolution

**Pneumatic Enclosure (Version P only):**

- Air Input: 125 psi Max.
- Air Output: 2 to 75 psi (0.07 to 5.17 bar)
- Servo Valve Drive: Signal: 4 to 20mA
- Air Connection In: 3/8" NPT
- Air Connection Out: 1/4" NPT

**Weight:**

- DC Panel Mount: 1.6 lbs (0.73 kg)
- AC Panel Mount: 3.1 lbs (1.41 kg)
- DC Enclosure Mount: 5.1 lbs (2.32 kg)
- AC Enclosure Mount: 6.6 lbs (3.00 kg)
- Pneumatic Module: 4.6 lbs (2.09 kg)

- High Voltage Output Module: 2.9 lbs (1.32 kg)

#### **High Voltage Output Module (Version V only):**

##### Power Input:

- 115 OR 230 VAC 50/60Hz single phase. **Note:** 115 / 230 VAC factory set. Specify when ordered
- Input Power fused at 0.125A @ 115 VAC.
- Input Power fused at 0.063A @ 230 VAC

##### Output:

- 45, or 90 VDC, all @ 5 Amp with 115 VAC In
- 0 to 45 or 90 VDC, all @ 5 Amp with 230 VAC In

##### Signal Input:

- 0-10 VDC

#### **Optional RS232 Card:**

- Selectable Baud Rate: 4800, 9600, 14400, 19200
- Modbus RTU Interface, Jumper Configurable Null Modem or Standard communication

#### **Optional RS485 Card:**

- Selectable Baud Rate: 4800, 9600, 14400, 19200
- Modbus RTU Interface
- Jumper Configurable 2 or 4 wire mode

#### **Optional Pulse Tachometer Card:**

- Input: 0-50kHz, 1-50 VDC pulses

#### **Optional DC Tachometer Card:**

- 5-15 VDC Input: 0-15 VDC
- 15-250 VDC Input: 0-250 VDC

#### **Optional Relay Card:**

- Max Voltage: 230 VAC
- Max Current: 5A (with resistive load)

#### **Optional Enclosure:**

- Steel, powder resin painted, NEMA 1
- Dual Transducer Connectors - Amphenol MS3106A-10SL-3S

### **3.5 ENVIRONMENTAL CONDITIONS** (Ref. Appendix F for further information)

This section applies to equipment designed to be safe at least under the following conditions:

- Indoor use.
- Altitude up to 6500 ft (2000 meters).
- Temperature range: 32° F to 104° F (0° C to 40° C).
- Maximum relative humidity 95% over the temperature range (non-condensing).
- Main supply voltage fluctuations not to exceed +/-10% of the nominal voltage.
- Main supply transient overvoltages according to overvoltage category II of IEC 60364-4-443.
- Pollution Degree 2 in accordance with EN61010-1:2001.

### **3.6 STANDARD FEATURES**

**Flexible, Powerful Configuration:** The controller can be utilized in unwind, rewind, or intermediate tension zones. It can be configured for standard (transducer feedback only) tension control, for line speed follow with tension trim or for diameter compensated line speed follow with tension trim modes of control. The PID based control algorithm features adaptive diameter compensation and acceleration compensation capability to handle a wide array of tension control applications.

**Informative, Intuitive User Interface:** The SteadyWeb 6™ user interface features a full color 5" touchscreen display for presenting real time tension and related process information and facilitating controller configuration and calibration. Illustrated prompts and color graphics make set up a breeze and allow for a short operator learning curve. Real time information is displayed in a clear and highly configurable manner with operator selectable use of line graphs, or an analog meter. The menu system



is easily navigable and on-screen information pages are provided for every menu, setting and function, acting as an on-screen manual.

**Multiple Stored Setups:** Up to 30 Setups can be stored in addition to the ACTIVE Setup. Operator programmable descriptive Setup names are possible with the controller's alphanumeric naming capability. Setups can be uploaded and downloaded to a PC via a USB port.

**Anti-Tamper Switch (Operator Lockout):** Disables operator access to certain menu functions and settings.

**Automatic Excitation Voltage Selection:** An intelligent transducer excitation system allows the controller to automatically adjust the excitation voltage in accordance with the connected transducer type; 5 VDC for Standard (STD) transducers or 10 VDC for Extended Range (XR) transducers. The system is also capable of detecting transducer wiring errors or fault conditions, such as a short circuit or open circuit conditions. Automatic excitation power shut down during short circuit or over-current conditions help protect both the controller and the connected transducers from damage.

**Digital Calibration and Control Technology:** Digital transducer calibration and tension control settings mean the controller will not suffer from the time, temperature or vibration induced drift that can be associated with analog circuitry and components.

**Isolated Control Output:** Standard +/-10 VDC (or a user-adjustable range within +/-10 VDC) or 4-20mA (jumper-selectable) control output isolated from chassis and transducer ground. Designed to prevent ground loop and noise issues common in industrial environments.



**WARNING:** The isolated output is designed to prevent ground loops and noise. It is not intended or approved for safety isolation of hazardous voltages. Do not install unit where the isolated circuit and chassis ground are more than 40 Vpk differential.

**Remote Tension Readout:** 0 to 10 VDC or 0 to 1mA (jumper-selectable) external meter or monitoring output proportional to tension. The 0 to 1mA output is designed to drive a 50 Ohm meter.

**Display Tension Damping:** Adjustable tension damping reduces flicker on the display and makes the tension readout more readable in certain situations.

**Tension Limit Switch (TLS):** An alarm is triggered to alert operators to preset low or high tension conditions. A TLS alarm message is displayed on the LCD and an optional relay can be energized. The alarm can also be configured to disable the control output. Purchase TLS option to get relay for external alarm use.

**Soft Start:** Used on braked unwinds. Actuated either automatically upon a loss of tension below a preset trip point (after an adjustable delay), by machine speed dropping below a preset speed trip point (after an adjustable delay), or immediately upon an external contact closure. In Soft Start mode, controller output is reduced to a preset (user-adjustable) low level to prevent brake lockup when the machine starts. When tension or line speed rises above their respective trip points or the Soft Start contact opens, the controller output switches to automatic control mode through a bumpless transfer.

**Taper:** Used in rewind zones. Taper causes tension to decrease as the roll diameter increases. The roll diameter is calculated from line and roll tachometer signals or measured directly by a follower roll or ultrasonic sensor. Taper helps produce a better quality roll by eliminating telescoping, crushed cores and too tight or too loose rolls.

**Hold / Ratio:** Used to sample and hold and/or ratio the output or setpoint. Ratio can also be used to ratio to the real-time line speed to allow for a smooth transfer between rolls in rewind splicing applications.

**Remote User Control Inputs:** Terminal block inputs are provided to allow for remote Tension On / Tension Off and Auto mode / Manual mode toggling using external switches or relays. Analog terminal inputs are also provided for remote Auto setpoint and Manual setpoint signals, either from a potentiometer or from an external 0-10 VDC source, such as from a Programmable Logic Controller (PLC).

**Remote Tension Amplifier Inputs (RTA):** Two sets of RTA inputs allow bypassing the internal tension amplifier to provide a tension signal by an external remote amplifier or indicator. This allows use of special amplifier functions, such as intrinsic safety, which are not available in the SteadyWeb 6™ controller, or to connect multiple pairs of transducers to the controller.

**Analog Line, Roll and Diameter Inputs:** 0-10 VDC input terminals are provided for Line Speed, Roll Speed, and Roll Diameter input signals. The speed inputs can be fed from tachometer outputs and the diameter input can be fed from a rider assembly or ultrasonic range finder. These signals can be used for Line Speed Follow and Diameter Compensated Line Speed Follow modes of operation. These signals can also be used for advanced tuning functions, such as Acceleration Compensation and Diameter Compensation. Optional tachometer cards can be used to handle voltages outside the 0-10VDC range or to interface with pulse tachometers.

**+10/15 VDC Customer Supply:** A jumper-selectable 10 VDC or 15 VDC, 100mA supply is provided to feed external potentiometers or to power diameter measurement sensors.

**Manual Control Mode:** The controller output is determined only by the setting of the Manual setpoint value. No output change occurs unless the setting is changed. Used during machine set up or troubleshooting.

**Automatic Control Mode:** The controller output is determined by the difference between the web tension and the Auto setpoint value. The internal regulator automatically varies the output as required to maintain the set tension.

**Emergency Stop:** The controller immediately goes into full output or minimum output (jumper-selectable) upon a break in the Emergency Stop circuit Full output is traditionally used in braked unwind applications, to stop the roll of material quickly. Minimum output is used for other applications. The Emergency Stop circuit can be bypassed if no Emergency Stop function is desired.

### 3.7 OPTIONS

- **230 VAC Power (230):** 230V 50/60 Hz power input. V version only. (For V-out module, controller can be 24 Vdc).
- **24V or 45V Output (24,45):** 24V or 45V output. Version V only.
- **4-20mA Output (420) :** 4-20mA current output. This replaces the standard 0-10V control output.
- **Bipolar 10 Volt Output (B10):** -10V to +10V output. Used on bi-directional machines (ex: inspection machine), or in Line Speed Follow. D version only.
- **Diameter Alarm (DA):** Unit produces an output at a pre-determined roll diameter. Requires diameter signal.
- **Speed Follow:** This is a function normally used on Version D controlling tension in an intermediate zone or surface driven rewinds and unwinds. The Control board contains a regulator circuit, separate from the tension regulator, that can accept a 0 to 10V line speed signal, one from a DC tach (**SFD**), or a pulse tach (**SFP**). The line speed signal causes the output of the controller to follow (go up and down with) line speed. The output of the tension regulator then trims the follower output as needed to maintain set tension.
- **DIN-Rail Mounting Clip (DRC):** Fits 35mm DIN rail. Available only on V version, for V-Out Module.
- **Metric Pneumatic Fittings (MPF):** "P" Version only.
- **Reverse Output (RO):** Increases output when tension exceeds set point and decreases when tension drops below set point. Used in intermediate applications where transducers are located after the nip rolls being controlled by the transducers or for driven unwinds.
- **RS232 (RS23) or RS485 (RS48):** An optional communications card provides serial communication using the MODBUS RTU protocol, allowing easy integration with computers or PLCs.
- **Serial Data Connector (DB9):** 9-pin connector for data transfer when using the RS232 and RS485 options. Enclosure version only.
- **Remote Tension Amplifier (RTA):** The internal tension amplifier is bypassed and the tension signal is provided by an external remote device such as the FireGuard™. This allows use of

special indicator functions, such as intrinsic safety, which are not available in the SteadyWeb 6™ controller or additional transducers.

- **Tension Limit Switch (TLS):** An open collector output actuates at a pre-set adjustable trip point. Can be used as a web break detector, or high tension warning. Low and high trip points are independently adjustable. Trigger delay is adjustable. Includes relay for triggering external alarm or light. Not compatible with TOR option - only 1 relay per controller.
- **Tension On Relay (TOR):** Tension On Relay provides a 250V, 5A relay interface. The relay function is operator-adjustable, and can be used for various functions such as a Tension On or Tension Limit Switch indicator. Not compatible with TLS relay function - only 1 relay per controller.
- **Taper Tension:** For rewind applications only. Causes tension to decrease as roll diameter increases as calculated electronically using inputs from: two DC tachs (**TTD**), two pulse tachs (**TTP**), one DC tach and one pulse tach (**TTDP**), or as sensed by a follower roll or ultrasonic sensor (**TTF**). Helps produce a better quality roll by eliminating telescoping, crushed cores, too tight or too loose rolls. Taper is adjustable from 0 to 100%.

### 3.8 ACCESSORIES

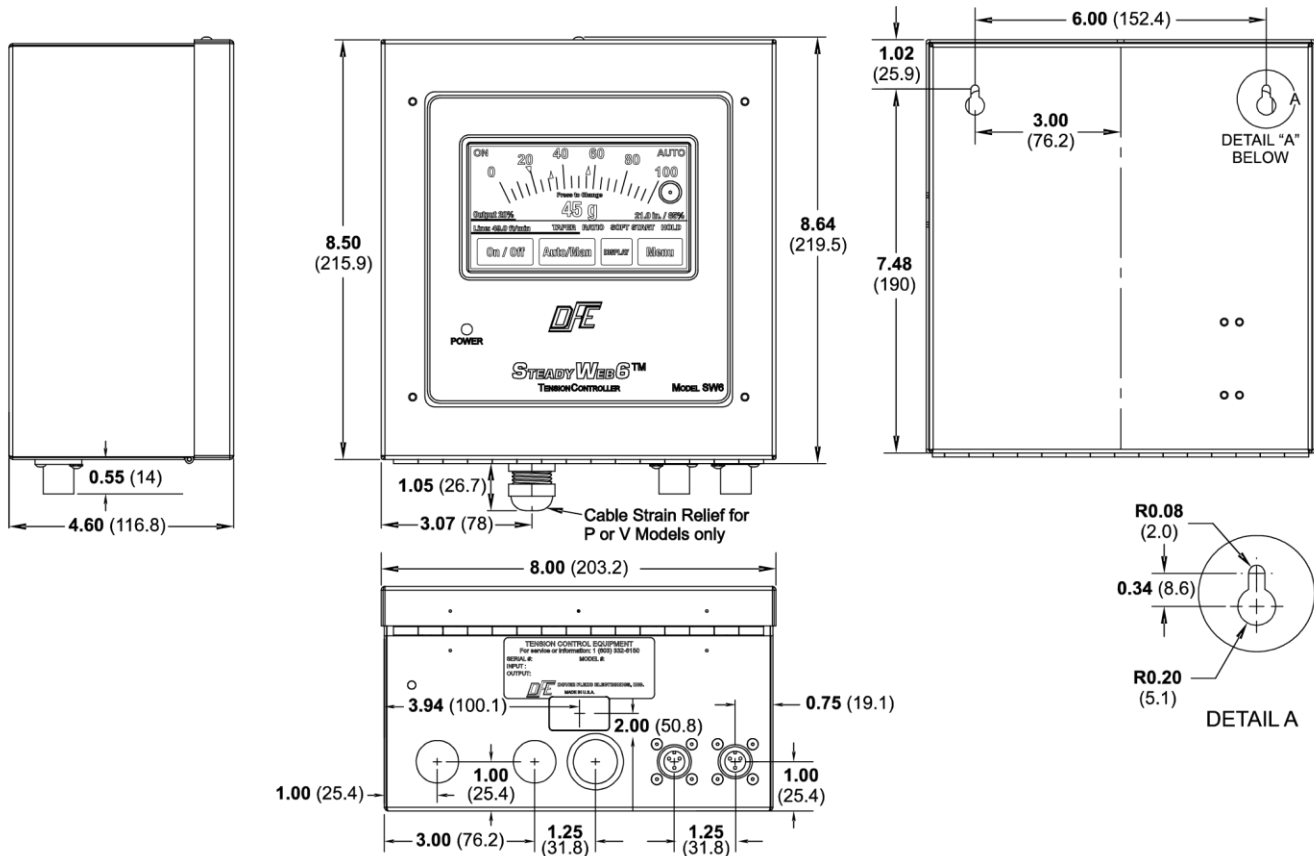
- **Remote Tension Meter:** Analog, 1 mA (DFE P/N: 722-1385) supplied as a single unit. Must be installed by user. This meter is also available in its own enclosure (DFE P/N: 723-2682, meter included).
- **Nonstandard Meter Scale:** Any other meter scale than standard ones offered by DFE. See Specifications for standard scales. Applies to remote tension meter listed above.
- **Remote Digital Tension Meter:** 4 digit, 0-1 mA (DFE P/N: 723-2307) supplied as a single unit without enclosure, or with enclosure (DFE P/N: 723-2660, meter included). Must be installed and powered (+24V) by user.
- **Ultrasonic Roll Diameter Sensor:** Compact user-adjustable sensor with a 0-10V output proportional to target distance (DFE P/N 149-0002).

DFE also offers a wide variety of interconnect cables. Please consult your Applications Engineer for more information.

# 4 INSTALLATION

The Anti-Tamper / Security Lockout is a jumper, shipped in the unlocked position, and may be used to prevent unauthorized changes to the controller. Refer to Section 7.14 for more detail regarding this feature.

## 4.1 DIMENSIONS INCHES (MM)



**Figure 4-1 - ENCLOSURE VERSION DIMENSIONS and VIEWS**

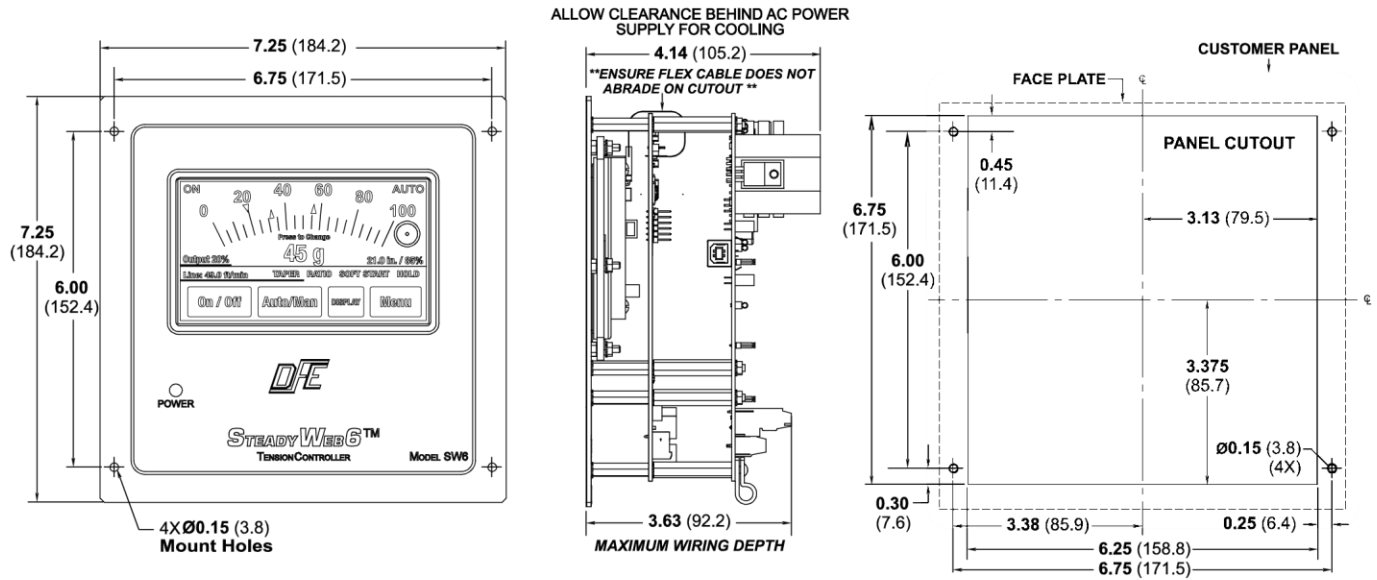


Figure 4-2 - PANEL VERSION DIMENSIONS and VIEWS

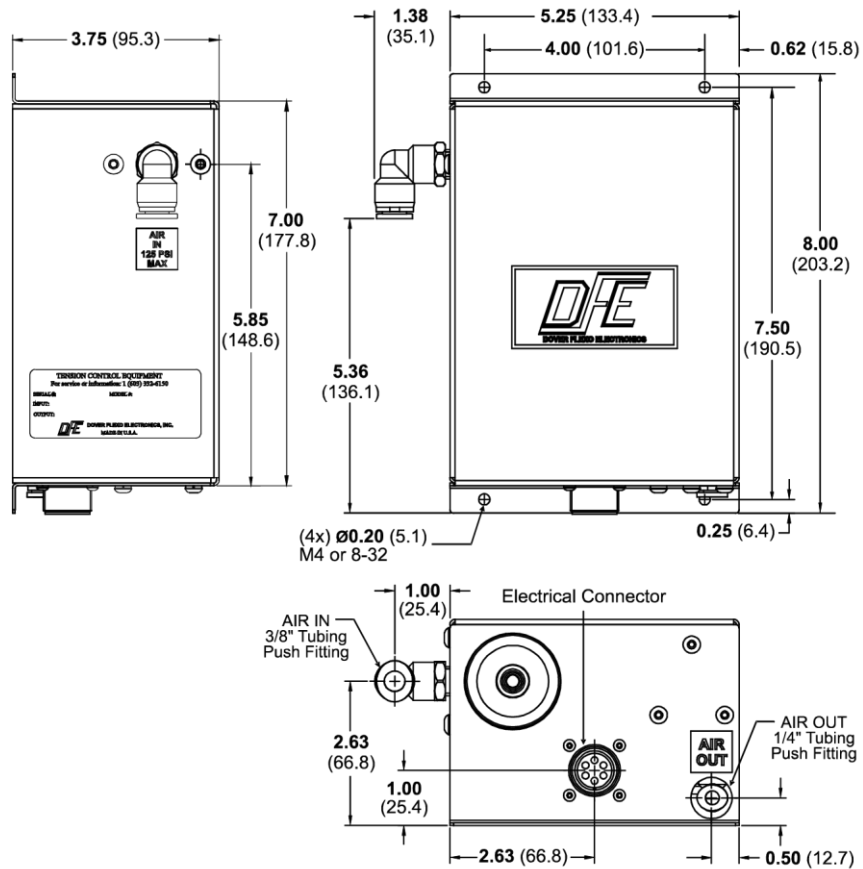
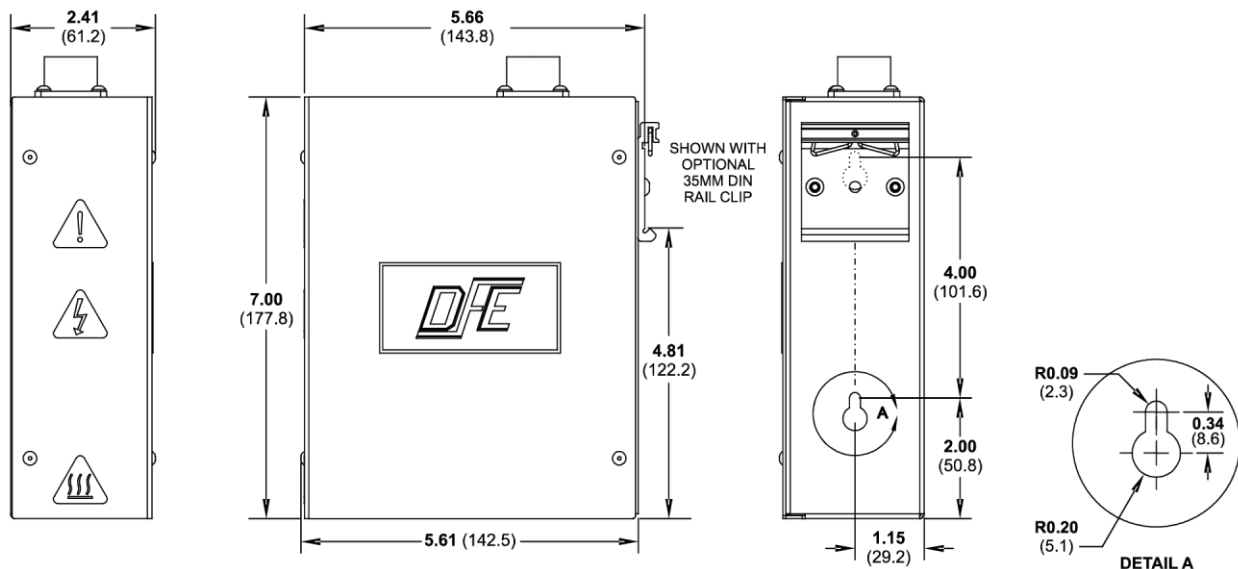


Figure 4-3 - PNEUMATICS ENCLOSURE DIMENSIONS FOR VERSION P



**Figure 4.4 - HIGH VOLTAGE OUTPUT ENCLOSURE DIMENSIONS FOR VERSION V**

## 4.2 SELECTION OF MOUNTING LOCATION

### 1. Enclosure Mount Versions

Select a mounting location on the machine frame or a wall that will provide convenient operator interaction and easy screen viewing. To ensure safety and proper operation, the SteadyWeb 6™ must be located away from dusty or wet environments. The unit should be mounted to a secure wall or surface that can support in excess of 30 lbs (13.6 kg). As the controller's front panel is hinged to the bottom of the enclosure, ensure that the mounting location will allow the front panel to swing open and down unobstructed. In addition, ensure there will be adequate room below the controller to allow for wire routing.

### 2. Panel Mount Versions

The panel mount configuration should be installed in a cabinet or enclosure that can support in excess of 15 lbs (6.8 kg). The controller should be positioned for convenient operator interaction and easy screen viewing. To ensure safety and proper operation, the SteadyWeb 6™ must be located away from dusty or wet environments. Ensure there is a minimum of 5" (12.7 cm) clearance behind the mounting panel to allow for physical fit of the controller with room for air circulation. In addition, ensure there will be adequate room below the controller's mounting location to allow for wire routing to the input/output terminal blocks.

**IMPORTANT:** Ensure flex cable does not abrade on cutout! See Fig. 4-2.

### 3. Version P Only

The pneumatic enclosure is designed for mounting close to your brake or clutch. This allows for a short length of tubing between the pneumatic output and the brake or clutch. In addition to a shop air supply connection, a signal cable must be run between the pneumatic unit and the controller. Choose a location which is free from vibration and that is located away from dusty or wet environments. The pneumatic enclosure should be mounted to a secure wall or surface that can support in excess of 20 lbs (9.1 kg). Ensure there will be adequate room around the mounting location for wire and pneumatic tube routing. Air should be clean and dry - no oil.

#### 4. Version V Only

The High Voltage output enclosure for 90V and 45V output versions is designed for mounting close to your electric brake or clutch. Unlike for the 90V and 45V output versions, the 24V version is fully enclosed within the SteadyWeb 6™ Enclosure Mount and Panel Mount versions and requires no separate high voltage output enclosure. It requires a dedicated AC power feed. In addition, a signal cable must be run between the V-Out module and the controller. To ensure safety and proper operation, the V-Out enclosure must be located away from dusty or wet environments. It should be mounted to a secure wall or surface that can support in excess of 12 lbs (5.5 kg). Ensure there will be adequate room around the mounting location for wire routing.

## 4.2 SAFETY AND EMC REQUIREMENTS



**WARNING:** If this equipment is not connected or operated in the manner specified, the operating safety of this unit or of connected equipment cannot be guaranteed.



**WARNING:** The isolated output is designed to prevent ground loops and noise. It is not intended or approved for safety isolation of hazardous voltages. Do not install unit where isolated circuit and chassis ground are more than **40 Vpk** differential.



**WARNING:** AC versions of the SteadyWeb 6™ controller are designed for single phase AC operation only. To prevent product damage and potential hazard, do not connect them across three phase lines or three phase circuits.

### 1. AC Power Configuration

For safety reasons, it is necessary to use appropriate wiring for your line voltage connections and for safety grounding. Make your ground connection between a reliable earth ground and the safety ground of your controller using a wire with a gauge of at least 16 AWG (or a cross-sectional area of at least 1mm<sup>2</sup>) and insulation rating of at least 600V. Make your AC line voltage connections with wire gauge of at least 16 AWG (or a cross-sectional area of at least 1mm<sup>2</sup>) and insulation rating of at least 600V for each conductor.

### 2. DC Enclosure Mount Configuration

For DC enclosure mount units, the length of wire inside the enclosure should be long enough to allow the front panel to open fully without putting any strain on wire, but no longer. Flexible, stranded wire should be used to allow flexing around the enclosure hinge when opening and closing the front panel. Solid wire should not be used. Be sure to route the 24 VDC power supply wires through the side cable clamp as shown in Figure 4-8, 24 VDC Electrical Connections.

### 3. AC and DC Power Configurations

Secure the power wiring to prevent inadvertent removal or strain on the input terminal. For enclosure mount units, this wiring should be secured at the power inlet of the enclosure. An external switch or circuit breaker is required for power disconnection of the SteadyWeb 6™. It is recommended that this switch or circuit breaker be located near the equipment and be well labeled.

### 4. Version V Only

For safety reasons, it is necessary to use appropriate wiring for your line voltage connections and for safety grounding. Make your ground connection between a reliable earth ground and the safety ground of your V-out module using a wire with a gauge of at least 12 AWG (or a cross-sectional area of at least 2mm<sup>2</sup>) and insulation rating of at least 600V. Make your AC line voltage connections with wire gauge of at least 12 AWG (or a cross-sectional area of at least 2mm<sup>2</sup>) and insulation rating of at least 600V for each conductor. Secure this wiring to prevent inadvertent removal or strain on the input terminal.

An external switch or circuit breaker is required for power disconnection of the V-Out module. It is recommended that this switch or circuit breaker be near the equipment and be well labeled.

It is necessary to remove the V-Out Module cover (held in place by four M3 screws) to mount the non-DIN rail version of the output module to a supportive wall. It is also necessary to remove the cover to access and wire into the module's terminal blocks



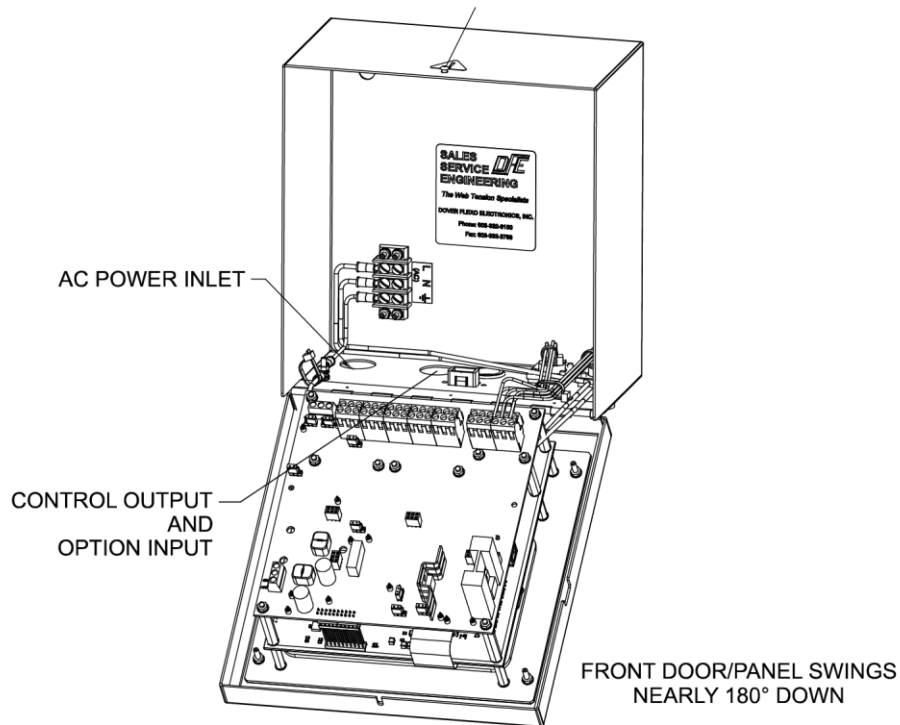
**WARNING:** Always keep the V-Out Module enclosure closed with the cover firmly tightened down while power is connected to the module.

## 5. Shielding

For maximum EMC performance a proper transducer installation, including shielded cables, must be used. Cables manufactured by DFE meet this requirement. In addition to the transducer cable shielding, a shielded meter cable and meter in enclosure are required when an accessory meter is used. Contact DFE for more information. Cable shielding must be attached to a SHIELD connection on the terminal blocks, or to an appropriately grounded enclosure.

## 6. Enclosure Mount Versions

Enclosure mount versions of the SteadyWeb 6™ controller use a hinged enclosure. The front of the controller hinges down to allow access to the internal circuit boards and adjustments. The enclosure should always be mounted in a location that allows unobstructed opening and closing of the front panel. When the front panel is closed, an M3 screw on the top of the enclosure must be tightened down to firmly keep the panel in place and prevent unintentional opening (see Figure 4-5, Enclosure Version Service Access). The panel should be kept shut with the latch screw tight at all times when the controller is in use. Only qualified service technicians may open the enclosure and access the internal circuit boards.



**Figure 4-5 – ENCLOSURE VERSION SERVICE ACCESS**





**WARNING:** Always keep the enclosure closed with the latch screw firmly tightened down during normal operation.



**WARNING:** Only qualified personal may open the controller enclosure to access internal circuit boards and adjustments. When working with AC powered versions of the controller, the AC power rails will be exposed when the front panel is opened. Standard safety precautions should always be used when working around AC power rails. Unless the servicing requires power applied to the unit, power should always be removed before opening the enclosure.

## 7. Electrostatic Discharge Protection

The controller circuitry contains sensitive devices that are susceptible to damage from ESD (Electrostatic Discharge). The controller's power inputs, I/O terminals, push buttons, etc., have been designed to be protected from the high level of ESD present in typical industrial and web processing environments. When accessing the circuit boards directly, however, unprotected devices are exposed to direct contact. Because of this, proper ESD precautions should be followed when servicing the controller, such as wearing ground straps.

## 4.3 INSTALLATION INSTRUCTIONS

### 1. Enclosure Versions

For enclosure mount units, drill and tap two M4 (#8) holes up from the desired bottom of the enclosure to match the screw hole dimensions on the back surface of the SteadyWeb 6™ enclosure (see Fig. 4-1, Enclosure Mount Dimensions and Views). The enclosure is fastened to the mounting surface you have chosen by two M4 (#8) screws. Install the screws on the mounting surface. Leave the screws loose about 6 turns. Position the keyholes in the back panel of the enclosure over the screws and slide it down until it locks in place. The cover must be open to tighten the mounting screws and secure the enclosure in place.

### 2. Panel Versions

For panel mount units, drill four holes and cut an opening centered in the holes (see Fig. 4-2 Panel Mount Dimensions and Views). Mount your Panel style controller in the hole using four M3 (#4) nuts and screws.

### 3. Version P Only

The pneumatic enclosure should be located in the area of your clutch or brake. Drill and tap four M3 (#4) holes in a rectangle (see Fig. 4-3, Pneumatic Enclosure Dimensions). The enclosure is fastened to the mounting surface you have chosen by four M3 (#4) screws. The pneumatic servo is sensitive to any mounting off it's vertical axis. Mounting off vertical axis can cause error in output pressure.

### 4. Version V Only

The High Voltage Output module, required for 45 VDC and 90 VDC only, should be located in the area of your clutch or brake. If you are using the DIN Rail Clip (DRC) option, the V-Out module may simply be clipped to a DIN rail. If you are using the Enclosure mount style without the DRC option, drill and tap two M4 (#8) holes (Fig. 4-4, High Voltage Module Dimensions) to match the screw hole dimensions on the back surface of the V-Out enclosure. The enclosure is fastened to the mounting surface you have chosen by two M4 (#8) screws. Install the screws on the mounting surface. Leave the screws loose about 6 turns. Position the keyholes in the back panel of the enclosure over the screws and slide it down until it locks in place. The cover must be open to tighten the mounting screws and secure the enclosure in place. This module is not sensitive to mounting at any angle.

## 4.4 TRANSDUCER VOLTAGE SELECTION

Unlike previous DFE products, the transducer excitation voltage in the SteadyWeb 6™ is not normally set via a jumper or switch setting. The SteadyWeb 6™ features an intelligent transducer excitation system that allows it to automatically adjust the excitation voltage in accordance with the type of connected transducers (5 VDC for Standard (STD) Transducers and 10 VDC for Extended Range (XR) Transducers). The intelligent excitation system also monitors for wiring errors and/or transducer faults such as short circuit or open circuit conditions. When such faults are detected, an error message is displayed on screen describing the detected fault.

The system works by independently monitoring the current feeding each half of the transducer bridge. For this reason, it is important when wiring transducers directly to the terminal block connections (as opposed to using the Amphenol connectors) to use all 6 transducer interface terminals, which include a separate EXC+ and EXC- terminal for each half of the transducer bridge. Incorrectly wiring both transducers to the same excitation power terminal pair will lead to false errors as the controller will see what appears to be an open condition on the unused pair of excitation power terminals and an over current condition on the other pair.

When wiring to the terminal block interface, it is also important to keep in mind that one pair of excitation power lines should have reversed polarity from the other pair. This ensures that tension changes cause the signal voltages from each half of the transducer bridge to move away from each other, resulting in a differential signal (see Figure 4-11, Control Board Transducer Electrical Connections and Remote Option).

In certain situations, the Auto Excitation Voltage feature may be undesirable, such as when using DFE LT transducers or other unique transducers that don't feature the normal resistance ranges of DFE Standard and Extended Range transducers. In such cases, the excitation voltage can be locked to a specific value (5V or 10V) by programming the **Excitation Voltage** setting, located in the *Setup Menu > Tension Control Setup* menu (see Section 5, User Interface Overview, for a menu navigation overview). When the **Auto** excitation setting is disabled, all excitation error messages are disabled with the exception of over-current and short-circuit error messages.

The factory default **Excitation Voltage** setting is **Auto**. When in **Auto** mode, the excitation voltage defaults to 5V except if, and only if, an XR transducer is sensed on both sides of the transducer bridge, in which case 10V excitation be activated.

During an over-current or short circuit condition, the excitation power is disabled to protect the controller and connected transducers, and an error message appears on the tension display screen. In this situation, the controller will periodically (around once a second) briefly enable excitation power to see if the over-current or short circuit condition has been removed and if it hasn't, shuts excitation power back down.

## 4.5 CONTROL OUTPUT SELECTION

The isolated control output can be configured for either +/-10V output or 4-20mA output by setting jumpers JP2 and JP3 located directly behind the control output terminal block (refer to Figure 4-6, Output Jumpers). If voltage output is required, place jumpers on pins 2 and 3 (labeled +/-10) on both JP2 and JP3. If 4-20mA output is required, place jumpers on pins 1 and 2 (labeled 4-20) on both JP2 and JP3.

**NOTICE** Both jumpers must be in the same position or incorrect operation will result.

When set to voltage mode, the controller is capable of producing a -10V to 10V control signal. This can be reduced to a smaller voltage range by adjusting the **Positive Output Limit** and **Negative Output Limit** settings, located in the *Setup Menu > Control Output Setup* menu (see Section 5, User Interface

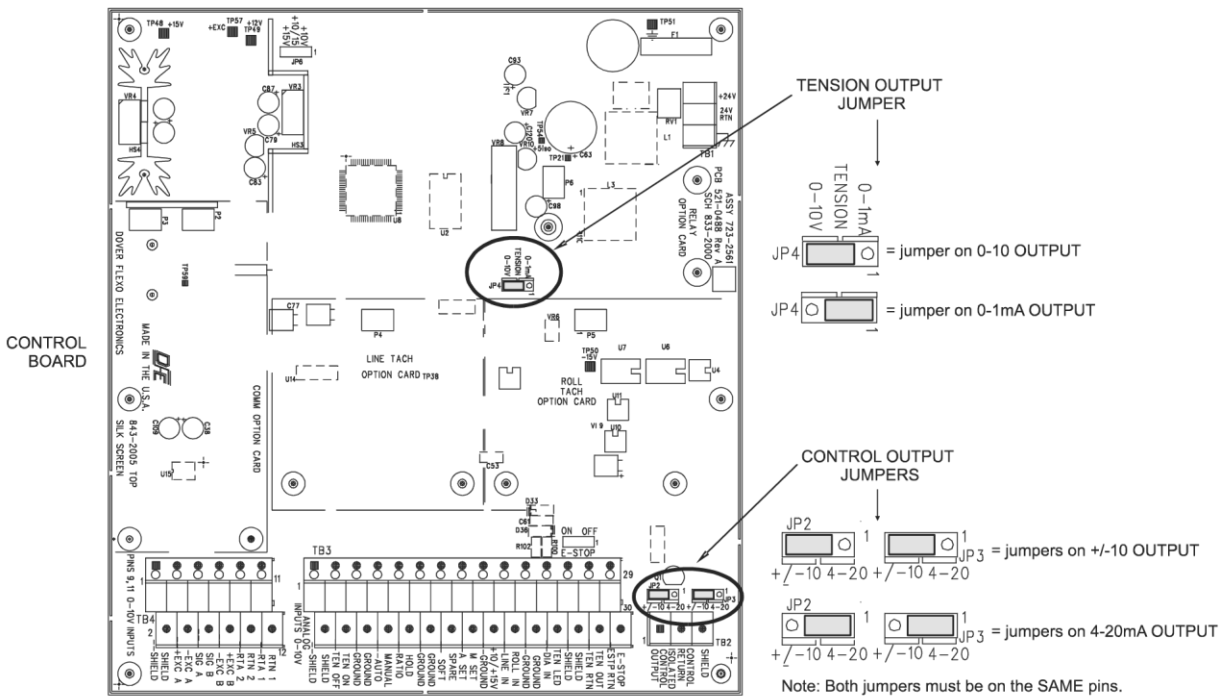
Overview, for a menu navigation overview). Setting **Negative Output Limit** to 0% and **Positive Output Limit** to 100% for example, will limit the output to a 0 to 10V signal. Setting both to 50% will limit the output to within -5V and 5V. When using the 4-20mA current output, the **Negative Output Limit** setting should be set to 0% and the **Positive Output Limit** should be set to 100%. The output, in both current and voltage mode, is isolated from chassis and transducer ground. This prevents ground loops and related noise issues which can be common in industrial environments.



**WARNING:** The isolated output is designed to prevent ground loops and noise. It is not intended or approved for safety isolation of hazardous voltages. Do not install unit where the isolated circuit and chassis ground are more than **40 Vpk** differential.

In addition to the control output range, the control direction is also adjustable through the **Control Output** setting, also located in the *Setup Menu > Control Output Setup* menu. When set to **Standard**, the output increases to increase tension, when set to **Reverse**, the output decreases to increase tension. **Reverse** is needed when the controller is used in an intermediate zone and the tension transducer is positioned after the drive motor, or when used in an unwind zone with a motor drive.

**NOTICE** Regardless of the software output limits, Emergency Stop activation will result in the output going to 0V (4mA) or 10V (20mA) based on the Output and ESTOP jumper settings (see 4.8 Emergency Stop Configuration).



**Figure 4-6 - OUTPUT JUMPERS**

## 4.6 TENSION OUTPUT SELECTION

The tension output can be configured as a 0-10V or 0-1mA signal representing tension by setting jumper JP4 on the control board (see Figure 4-6, Output Jumpers). The 0-1mA output is designed to drive a 50 Ohm meter. If a 0-10V output is required, place the jumper on pins and 2 and 3 (labeled 0-10V) on JP4. If a 0-1mA output is required, place the jumper on pins 1 and 2 (labeled 0-1 mA) on JP4.

## 4.7 EMERGENCY STOP CONFIGURATION

The Emergency Stop feature is useful for stopping large rolls of material when an external normally closed switch, contact or relay is opened. The circuit requires an external switch, contact or relay to be connected to the Signals Terminal Block (TB3) terminal 30 (E-STOP) and terminal 29 (ESTP RTN) (see Section 4.11, Standard Electrical Connections). The E-STOP terminal supplies approximately 5 VDC, which must be returned to the ESTP RTN terminal. If a break in the Emergency Stop circuit should occur, the Emergency Stop output circuit will activate.

The Emergency Stop circuit can be enabled or disabled with jumper JP5 (see Figure 4-7, Setup Jumpers). To Enable the Emergency Stop circuit, set the JP5 jumper to pins 2 and 3 (labeled ON). To disable the Emergency Stop circuit, set the jumper to pins 1 and 2 (OFF).

When the Emergency Stop circuit is active, the control output will produce either a zero (0V or 4mA) or full output (10V or 20mA) signal based upon jumper JP7 (see Figure 4-7, Setup Jumpers). Full output is traditionally used in braked unwind applications to stop the roll of material quickly. Minimum output is used for other applications. To set the Emergency Stop output to zero, set the jumper to pins 2 and 3 (labeled LOW) on JP7. To set the Emergency Stop output to full output, set the jumper to pins 1 and 2 (labeled HI) on JP7.

During an Emergency Stop condition a prominent E-STOP message is displayed along with the current tension reading on top of a red background on the user interface screen. The E-STOP display is active until the Emergency Stop condition is removed. The Tension Display and Menu Display screens are not accessible during an E-STOP condition.

In addition to the required Emergency Stop electrical connections and jumper settings, there are two software settings related to the Emergency Stop condition. The **Tension Off by ESTOP** setting, located in the *Setup Menu > Tension Control Setup* menu allows the user to specify whether tension control will remain On during an Emergency Stop condition (to pick up control after the Emergency Stop condition is removed) or whether it will be forced Off (forcing the operator to re-engage the tension output after an Emergency Stop condition) (see Section 5, User Interface Overview, for a menu navigation overview). The **Output During ESTOP** setting, also located in the *Setup Menu > Tension Control Setup* menu, allows for the selection of **High** or **Low** Emergency Stop output. This setting allows the user to specify the software output level during an Emergency Stop condition. Regardless of this setting, the hardware Emergency Stop jumper (JP7) will determine the actual output (High or Low) during an Emergency Stop condition. This setting is important if **Tension Off by ESTOP** is set to **No**, to allow a bumpless transfer out of the E-STOP condition when exiting E-STOP and returning to control mode. When **Tension Off by ESTOP** is set to **No**, this setting should always match the output specified by jumper JP7.

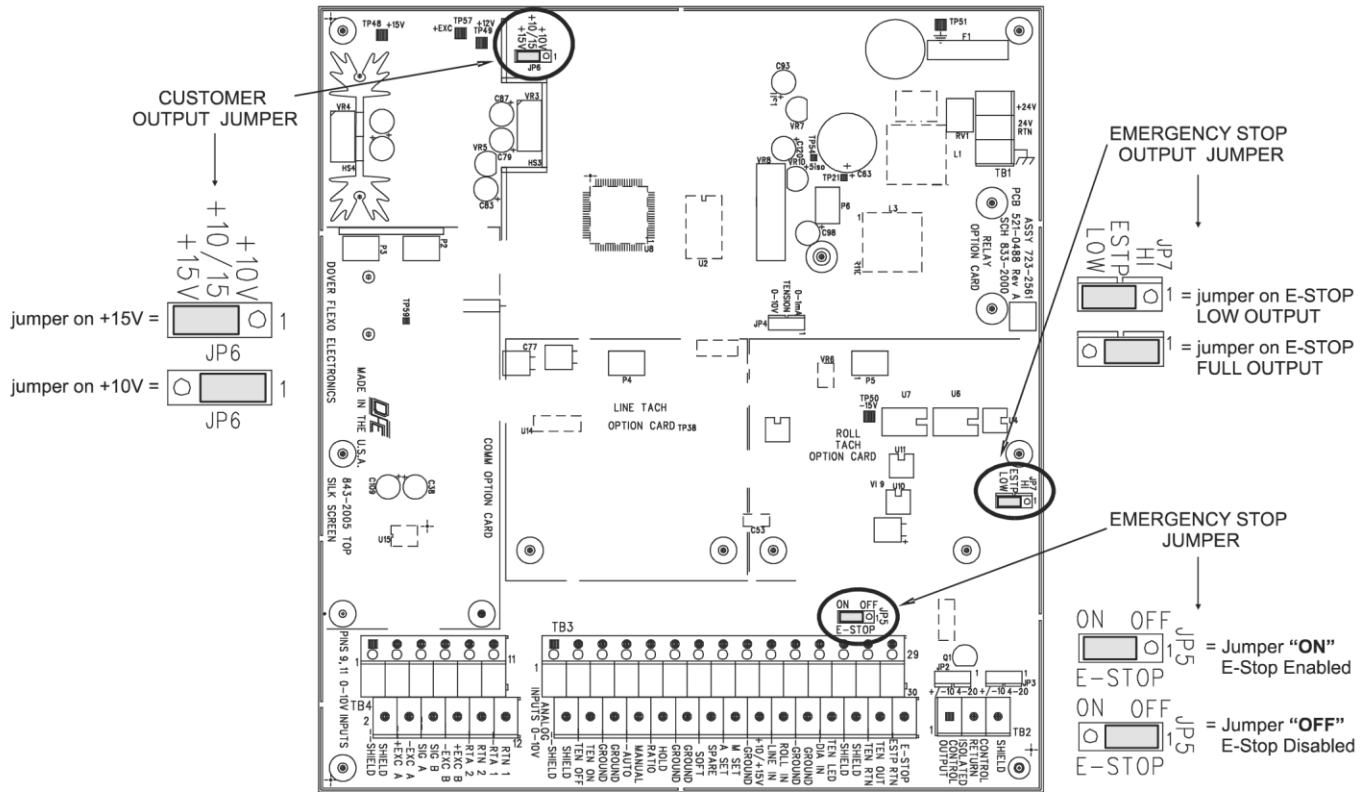


Figure 4-7 – SETUP JUMPERS

### 4.8 CUSTOMER +10/15V OUTPUT SELECTION

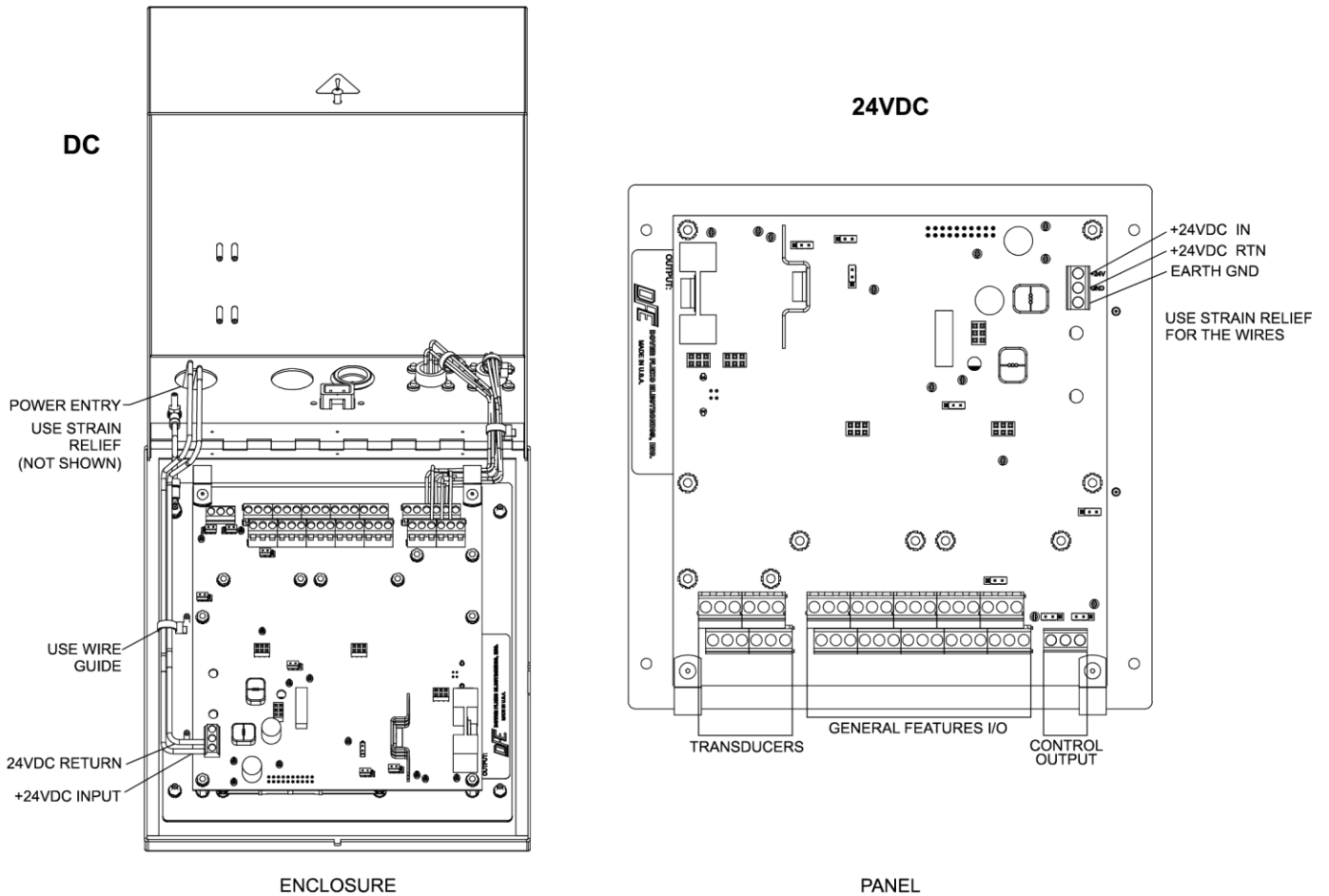
A selectable 10 VDC or 15 VDC rail is provided for customer use. This rail is designed to drive light loads, such as potentiometers used for external Auto or Manual setpoints, or in a roll follower setup. It should not be used for loads pulling greater than 100mA. The rail can be accessed via the Signals terminal block (TB3) terminal 18 (+10/+15V) and terminal 17 (GROUND) (see Section 4.11, Standard Electrical Connections).

The 10V or 15V selection is made by jumper JP6 (see Figure 4-7, Setup Jumpers). Placing the jumper on pins 1 and 2 (labeled +10V) sets the voltage rail to 10V. Placing the jumper on pins 2 and 3 (labeled +15V) sets the voltage rail to 15V.

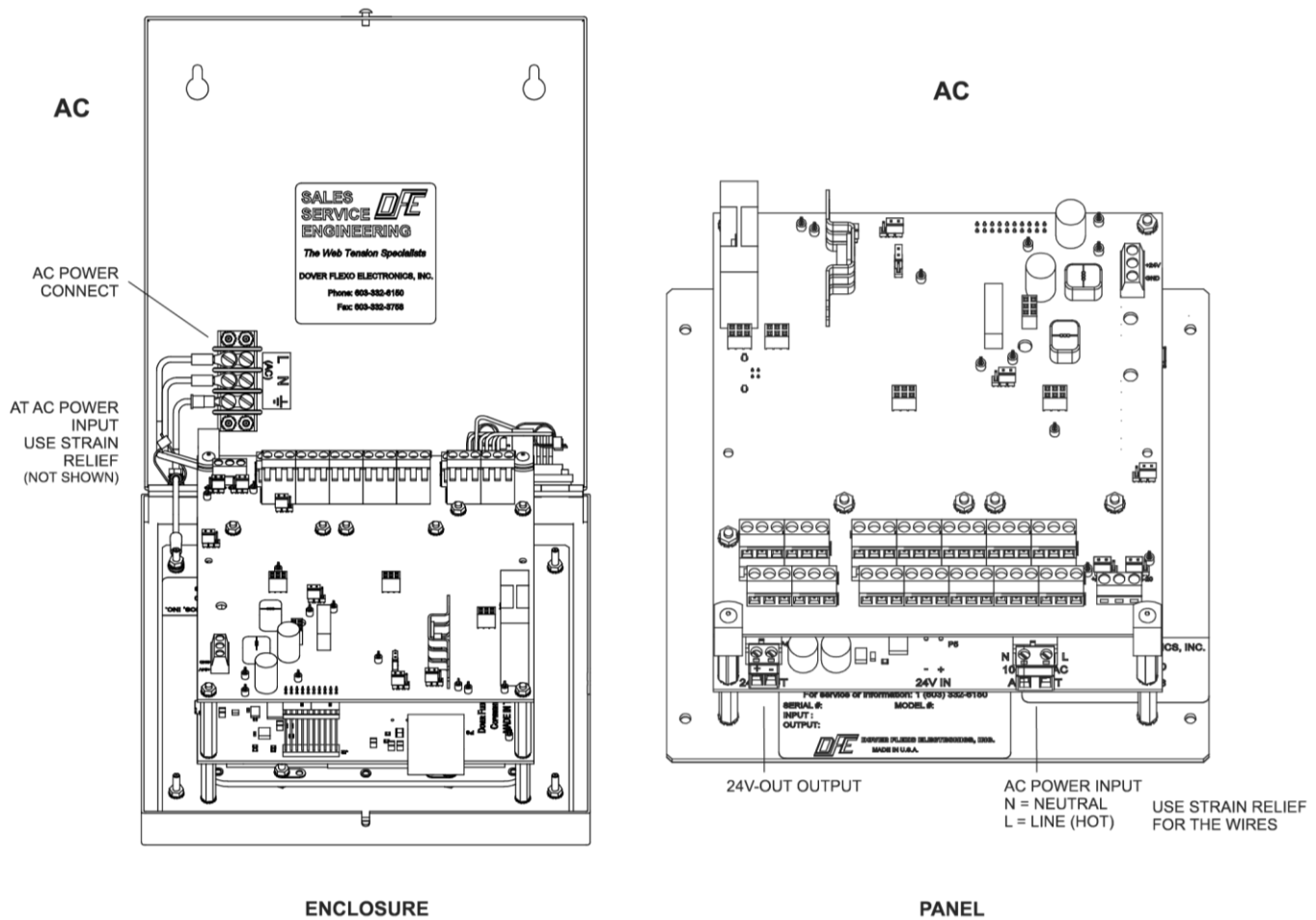
## 4.9 POWER ELECTRICAL CONNECTIONS

Make wiring connections as follows:

1. The insulation rating of all line voltage wiring must be at least 600V.
2. Keep line voltage wiring physically separated from signal wiring at the terminal block and at any other point in the installation.
3. Keep all wiring away from devices emitting electromagnetic radiation.



**Figure 4-8 – 24 VDC POWER ELECTRICAL CONNECTIONS**



**Figure 4-9 – AC POWER ELECTRICAL CONNECTIONS**

## 4.10 STANDARD ELECTRICAL CONNECTIONS

Make your wiring connections as follows:

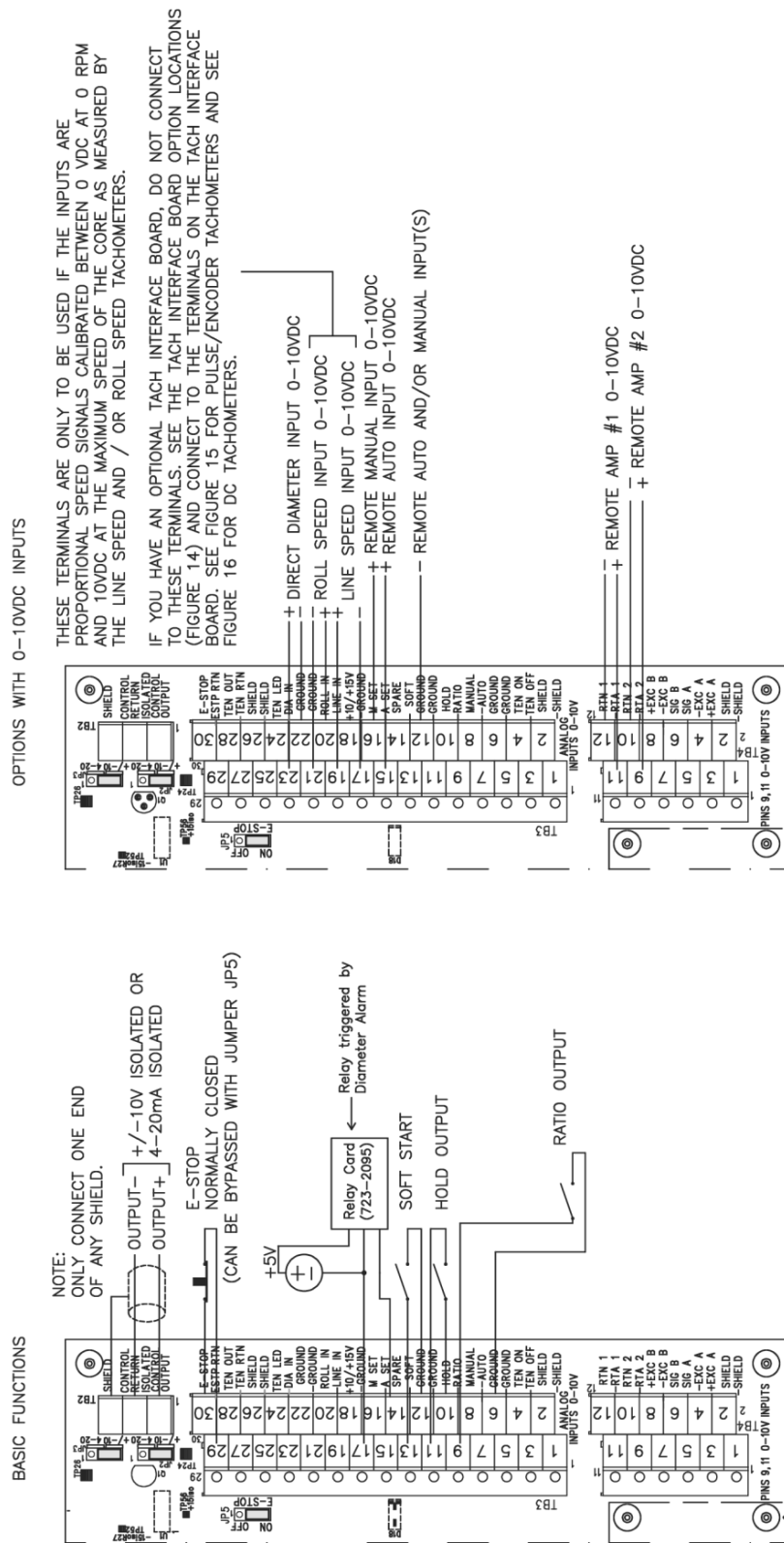
1. The insulation rating of all line voltage wiring must be at least 600V.
2. Keep line voltage wiring physically separated from signal wiring at the terminal block and at any other point in the installation.
3. Keep all wiring away from devices emitting electromagnetic radiation.
4. Connect cable shields to the closest Shield terminal on the relevant terminal block. Only connect signal cable shields on one end to avoid ground loops.

### Transducer connections

Enclosure mount units are equipped with Amphenol connectors that facilitate connection with DFE transducers. Panel mount units require wiring of the transducers directly to the Transducer terminal block (TB4). The Transducer terminal block contains a 6 terminal transducer interface.

The SteadyWeb 6™ intelligent excitation system monitors current feeding each half of the transducer bridge. For this reason, it is important when wiring transducers directly to the terminal block connections to use all 6 transducer interface terminals, which include a separate EXC+ and EXC- terminal for each half of the transducer bridge. Incorrectly wiring both transducers to the same excitation power terminal pair will lead to false errors as the controller will see what appears to be an open condition on the unused pair of excitation power terminals and an over current condition on the other pair.

When wiring to the terminal block interface, it is also important to keep in mind that one pair of excitation power lines should have reversed polarity from the other pair. This ensures that tension changes cause the signal voltages from each half of the transducer bridge to move away from each other, resulting in a differential signal (see Figure 4-11, Control Board Transducer Electrical Connections and Remote Option).



**Figure 4-10 - STANDARD AND 0-10 VDC CONTROL BOARD ELECTRICAL CONNECTIONS**



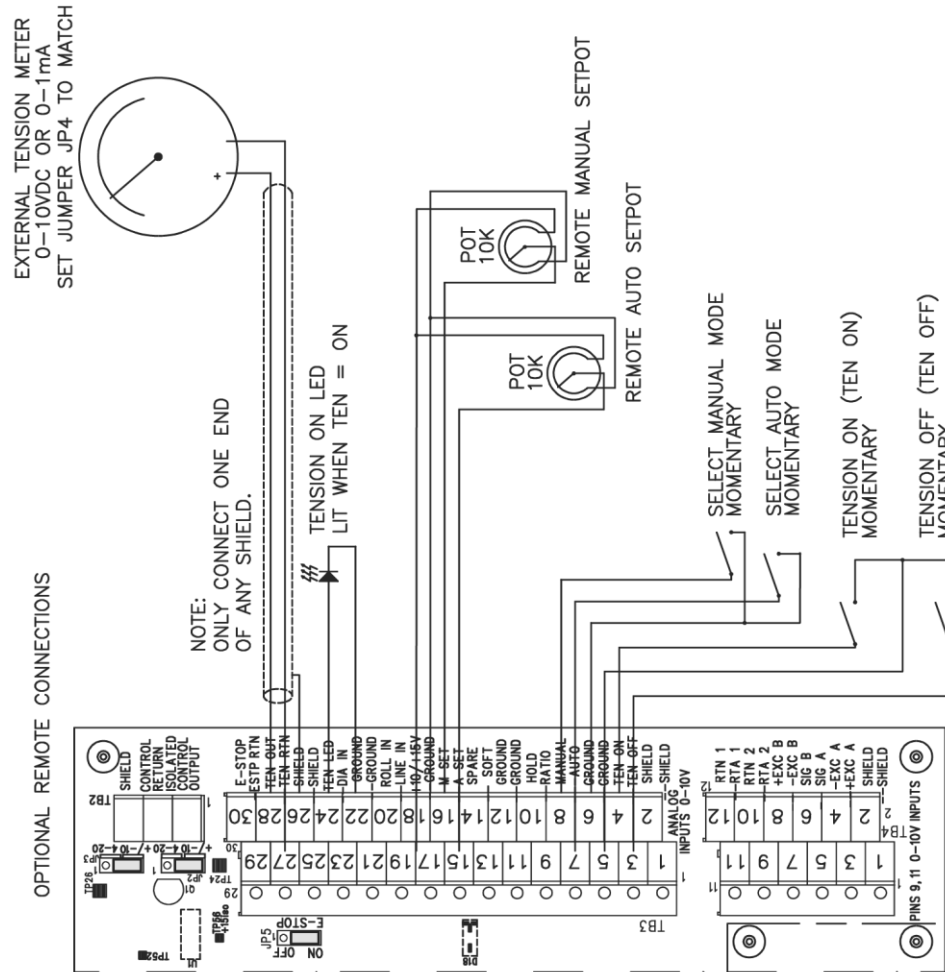
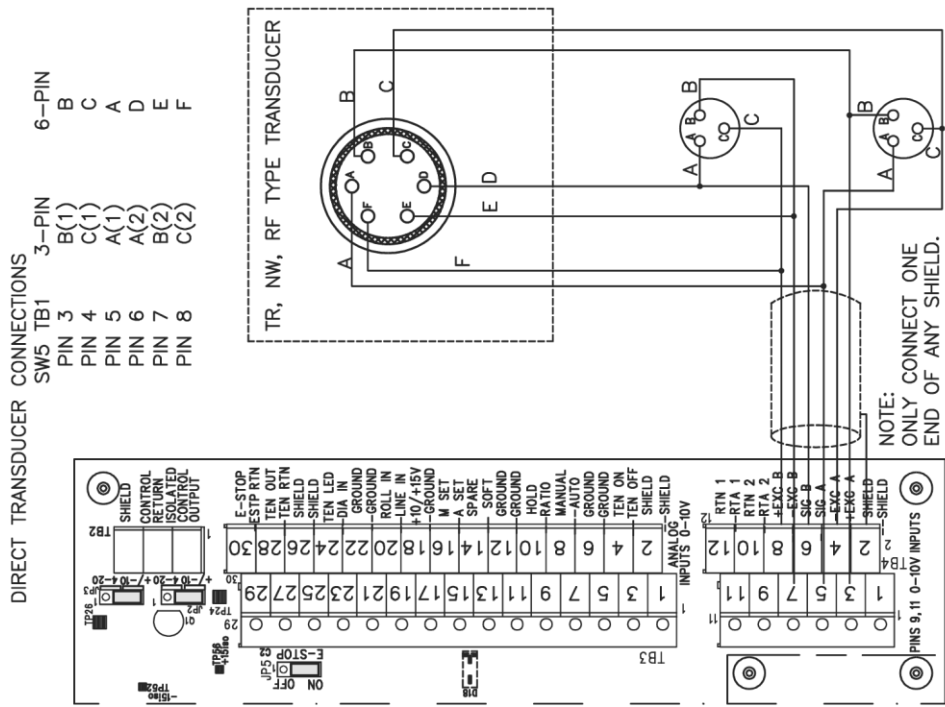
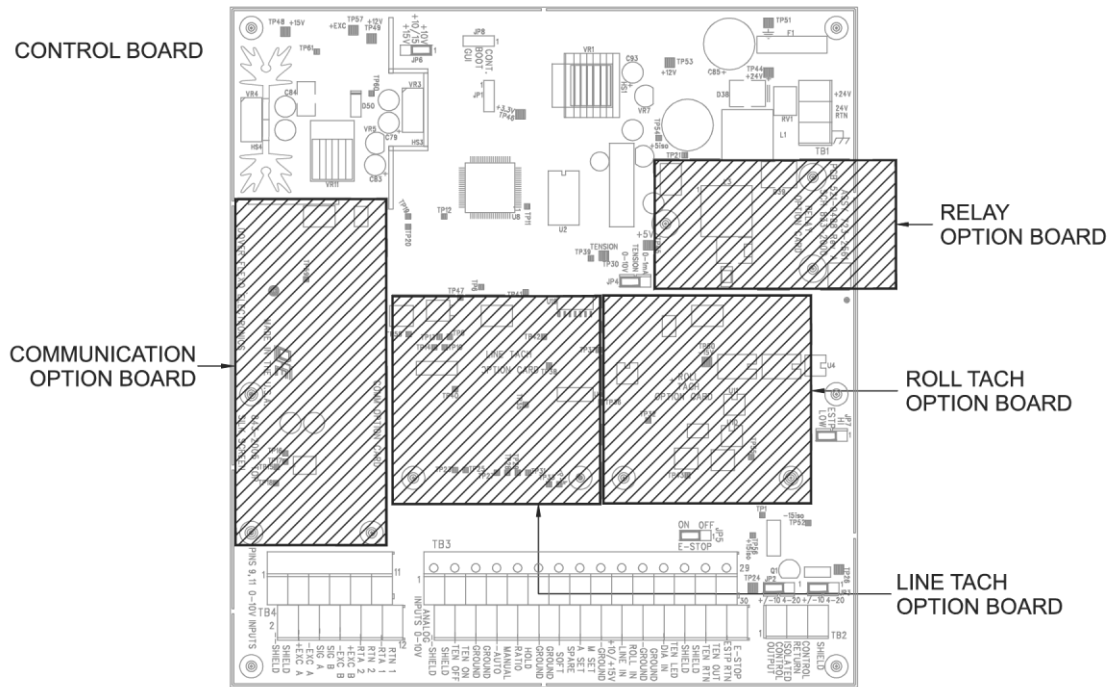


Figure 4-11 - CONTROL BOARD TRANSDUCER ELECTRICAL CONNECTIONS AND REMOTE OPTION

## 4.12 OPTION CARD MOUNTING LOCATIONS

The SteadyWeb 6™ main control board contains plugs and mounting hole locations for option card placement, allowing for a modular assembly. There are four main option card insertion areas, as shown in Figure 4-12, Option Card Mounting Locations. The option cards include a DC Tachometer card, Pulse Tachometer card, Relay card and various communication cards. Only one communication card can be installed at a time into the COMM OPTION CARD slot. The LINE TACH OPTION CARD slot and the ROLL TACH OPTION CARD slot can be populated with either the DC or Pulse Tachometer cards. The two tachometer cards (pulse and DC) have an identical footprint and can be populated in the LINE and ROLL slots in any combination. Option cards are installed as specified per order at the factory.



**Figure 4-12 - OPTION CARD MOUNTING LOCATIONS**

## 4.13 PULSE TACHOMETER OPTION CARD ELECTRICAL CONNECTIONS

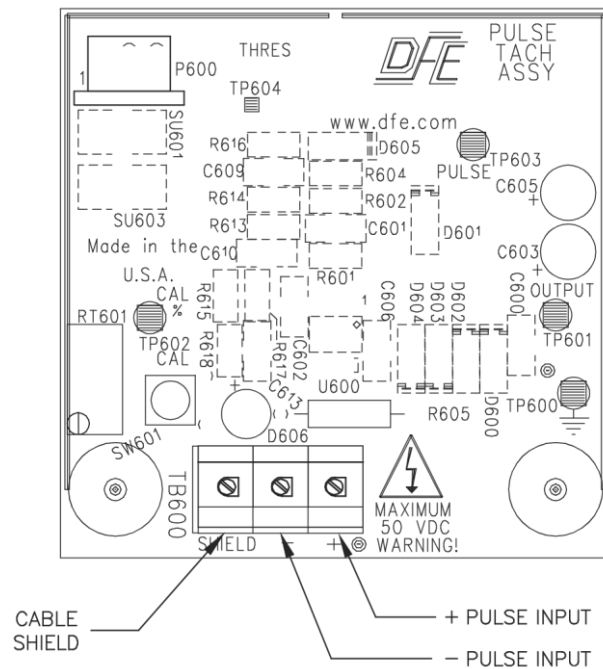


Figure 4-13 – PULSE TACHOMETER ELECTRICAL CONNECTIONS

## 4.14 DC TACHOMETER OPTION CARD ELECTRICAL CONNECTIONS

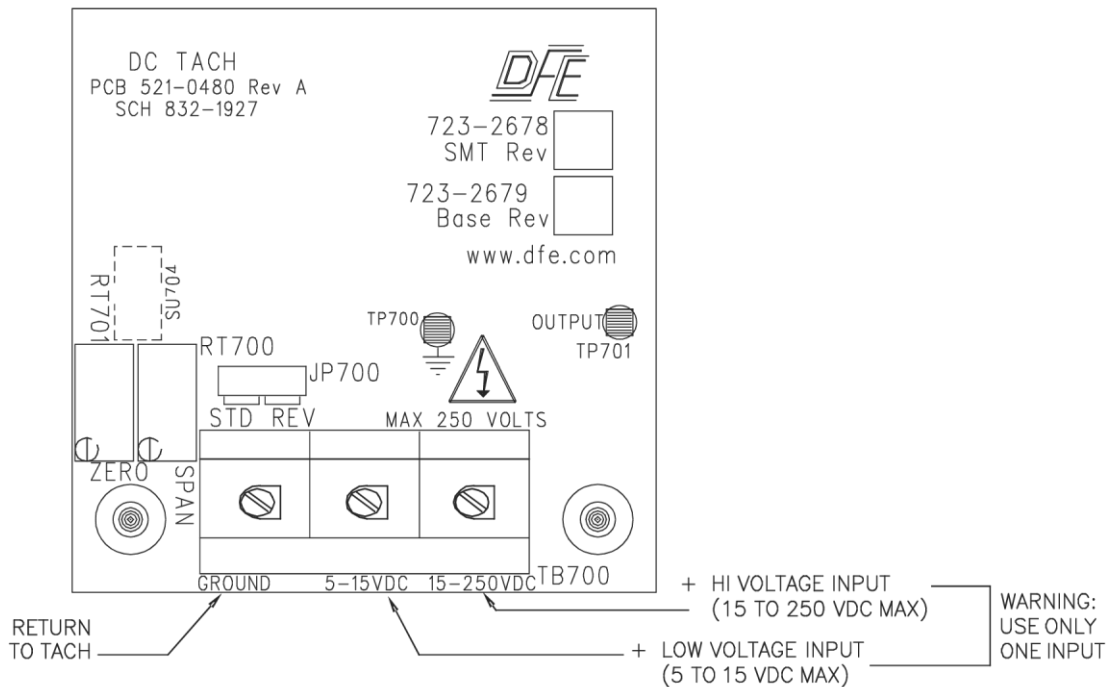
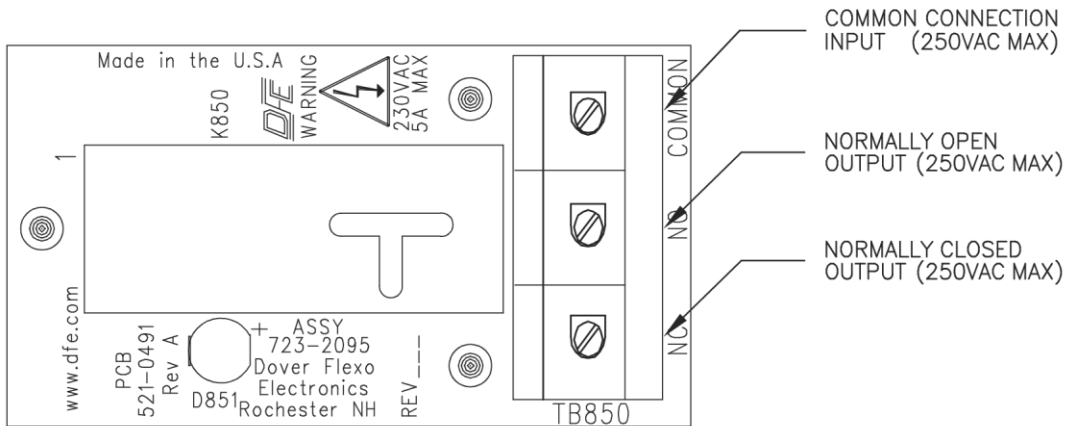


Figure 4-14 – DC TACHOMETER ELECTRICAL CONNECTIONS.

## 4.15 RELAY OPTION CARD ELECTRICAL CONNECTIONS

To minimize electromagnetic interference and extend the life of the relay, a resistor capacitor (RC) network may be needed across the relay connections. Any arcing should be minimized. The resistor wattage and capacitor voltage ratings should be sized to handle worst case conditions of the application, including spikes caused from switching inductive loads.

Values of 0.1uF and 100 Ohms are a good starting point. If significant arcing is still occurring, the capacitance may need to be increased. Instead of individual components, monolithic components, such as Cornell Dubilier Electronic's Quenchar® line of products may be easier to use.

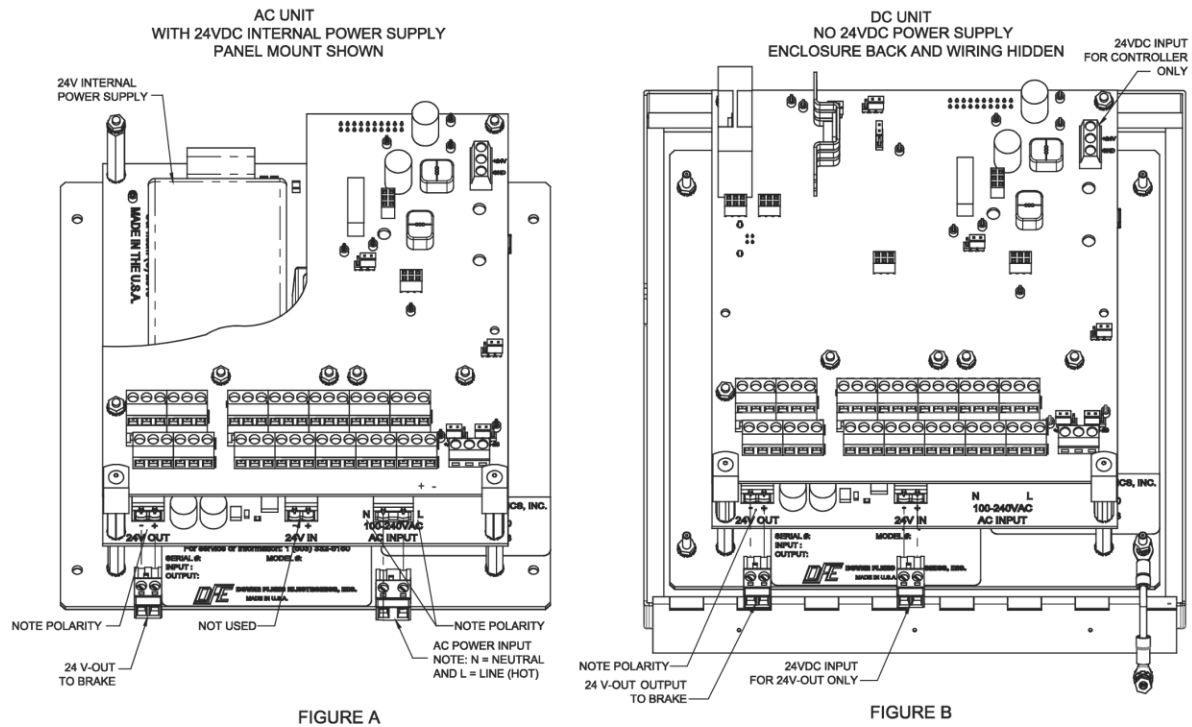


**Figure 4-15 – RELAY ELECTRICAL CONNECTIONS**

## 4.16 24VDC FOR BRAKES AND CLUTCHES

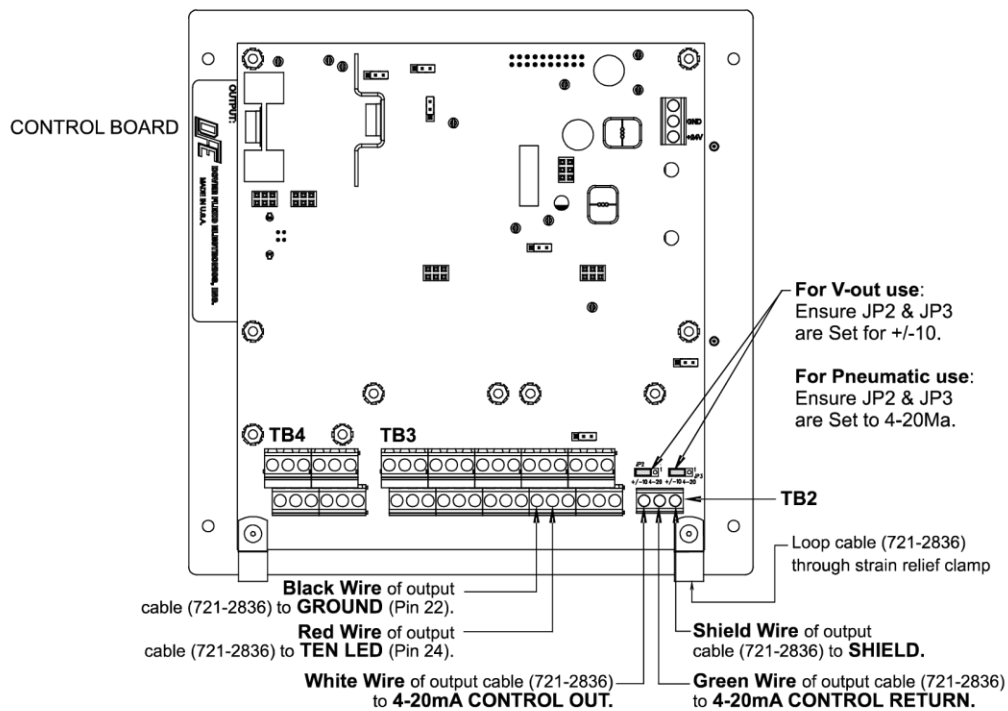
For AC versions of the SW6V controller, 24VDC up to 2.5 amps is supplied by an internal power supply shown in Figure 4-16(A), so no wiring to an external power supply is required. **Caution:** Do not connect external 24 VDC to an AC powered SW6 which has the internal 24 VDC power supply, as this will back feed the internal power supply.

For DC versions of the SW6V, power should be sourced from an external 24 VDC supply and be able to deliver 24 VDC up to 2.5 amps to the 24 VDC inputs shown in Figure 4-16(B). **Caution:** The 24 VDC supply for a brake or clutch should derive its power independently of 24 VDC for powering the controller. This will inhibit brown-outs of the controller during peak demand on the controlled device. For applications demanding 24 VDC above 2.5A, consult DFE Engineering.



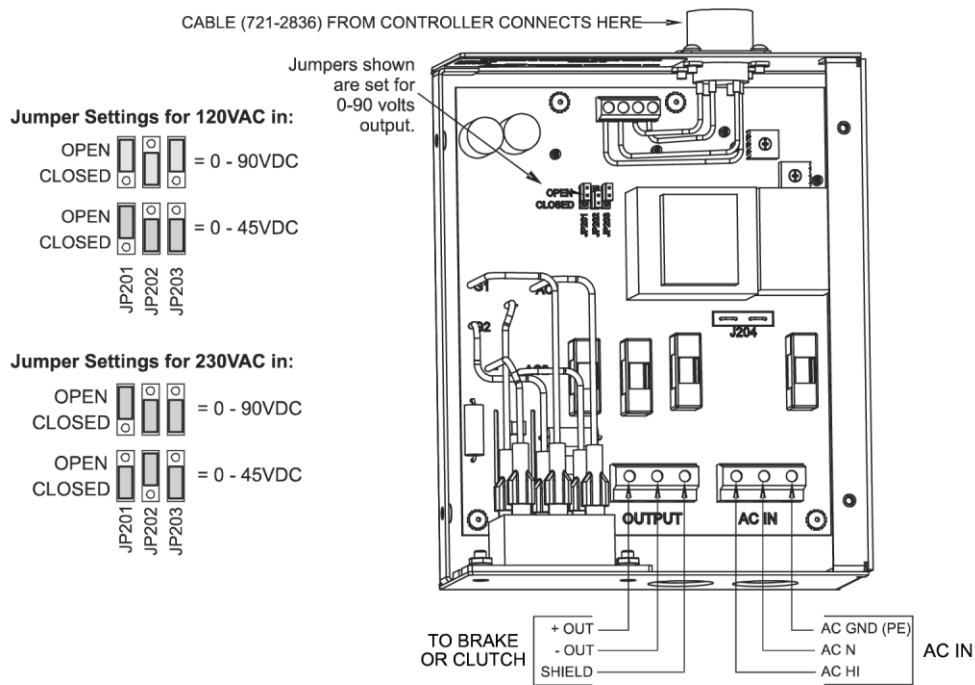
**Figure 4-16 – 24 VDC CONNECTIONS FOR BRAKES AND CLUTCHES**

## 4.17 EXTERNAL OUTPUT MODULE CABLE CONNECTIONS



**Figure 4-17 – EXTERNAL OUTPUT MODULE CABLE CONNECTIONS**

## 4.18 HIGH VOLTAGE OUTPUT MODULE ELECTRICAL CONNECTIONS



**Figure 4-18 – HIGH VOLTAGE OUTPUT MODULE ELECTRICAL CONNECTIONS**

## 4.19 COMMUNICATION OPTION CARDS ELECTRICAL CONNECTIONS

The SteadyWeb 6™ controller features optional RS232 and RS485 communication cards. Only one communication card can be populated at a time. Please refer to the specific communication card option manual for more information on wiring and configuring the card. Specific communication card manuals can be downloaded from the DFE website, [www.dfe.com](http://www.dfe.com).

## 5 USER INTERFACE OVERVIEW

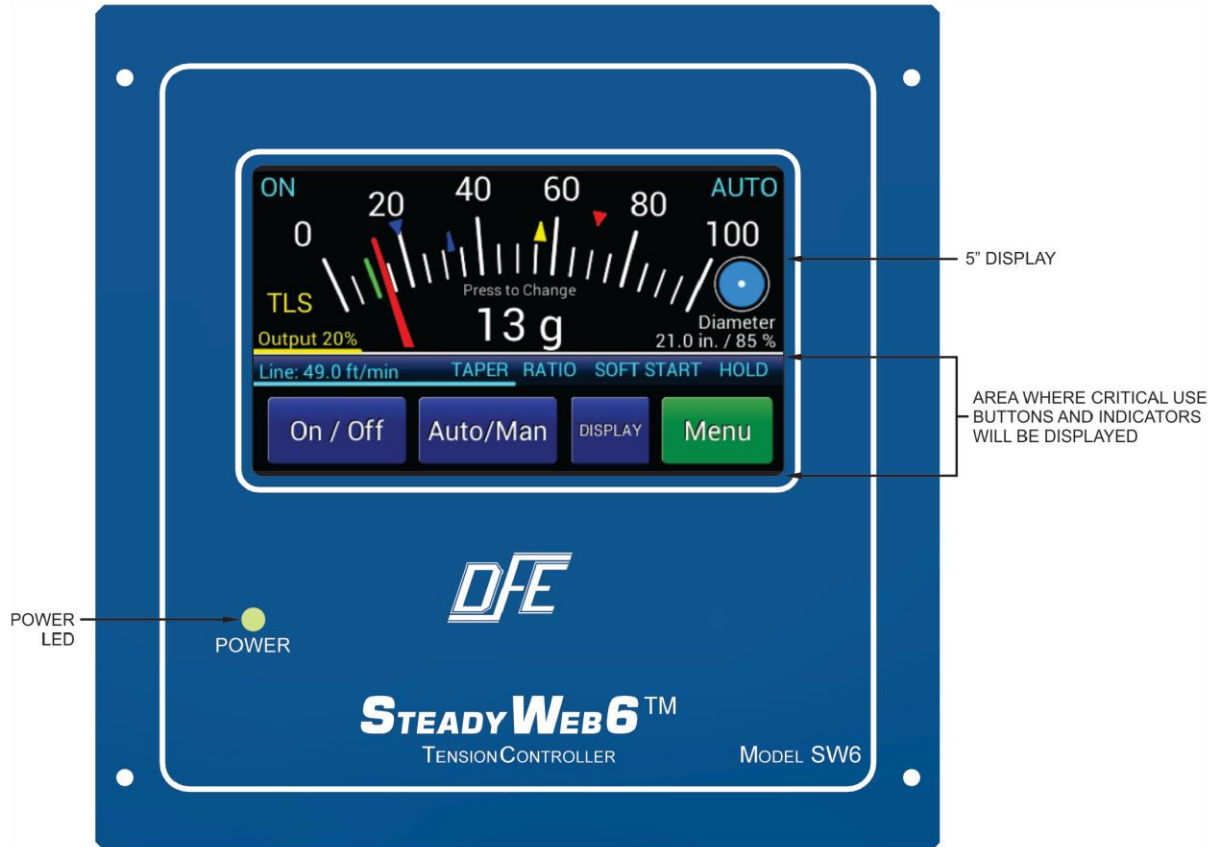


Figure 5-1 – STEADYWEB 6™ USER INTERFACE

### 5.1 MAIN INTERFACE DESCRIPTION

The SteadyWeb 6™ accepts all instructions and displays all information via a 5" touchscreen display (Fig. 5-1). All controller functions are context driven, and operate with color-coded buttons on the display. There are no mechanical knobs, switches or buttons to operate.

Please refer to Section 1.1 of the Operating Instructions Section of this manual for a more detailed description of the User Interface.

### 5.2 DISPLAY MODE DESCRIPTIONS

To display the tension setpoint, real time tension and related process information, the Tension Display mode should be used when making product, and the Menu Display mode should generally be used when making changes to the process.

**TENSION DISPLAY MODES:** Two different screens are available in Tension Display mode. Tension can either be displayed as a momentary value on an analog meter (Fig. 1-4) or as tension vs. time in a trend-line plot (Fig. 1-5) and may be toggled back and forth by pressing the Display toggle button.

Please refer to Section 1.2 for a more detailed description of the Tension Display Modes.

### 5.3 MENU DISPLAY MODE AND NAVIGATION

From either of the tension display screens, the Menu button will deliver the operator to the Main Menu (Fig. 5-2) where subordinate menus appear for further navigation. Note that the names of all menu screens are consistently displayed at the center of the top line.

Please refer to Section 1.3 for a more detailed description of the Menu Display Mode, the Operator Menu in particular, and Navigation through the menus in general.



**Figure 5-2 – MAIN MENU SCREEN**

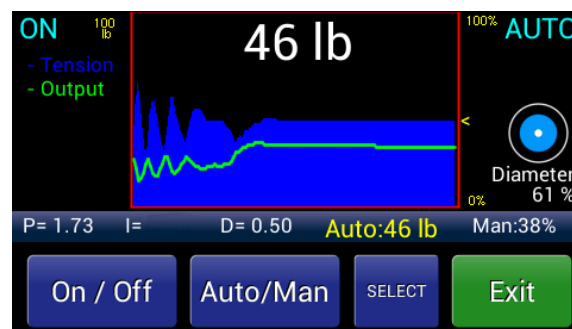
- 1. SETUP MENU** - Conforming to the same menu format as described in the Operating Instructions, the following sub-menus and settings are available for selection:
  - **Tension Control** – Select Tension Zone (Unwind, Intermediate, Rewind), Control FB (Closed Loop, Line Follow Tension), Tension Source (Transducer, RTA-1, RTA-2), Excitation Voltage (Auto, 5V Set, 10V Set)
  - **Diameter Setup** – Core Diameter (Set +/- increments of 0.1 inch), Change Full Roll Diameter (Set +/- increments of 0.1 inch), Change Diameter Input (Direct, or Tach Ratio Calc), Change Diameter Filter (Select 0.00 seconds up to 5.0 seconds), Calibrate Rider, Diameter Units (in, cm), Diameter Alarm (Off, On), Diameter Alarm Min (Set +/- increments of 0.1 units), Diameter Alarm Max (Set +/- increments of 0.1 units), Diameter Alarm Dly (0.1 sec to 5.0 sec)
  - **Line Speed Setup** – Max Line Speed (Set increments of 1 ft/min), Change Line Speed Units (ft/sec, ft/min, cm/sec, cm/min, m/min, Y/min), Change Line/Roll Filter Time (0.00 sec, 0.10 sec, 0.25 sec, 0.50 sec, 1.00 sec)
  - **Soft Start Setup** – Speed Soft Start (On/Off), Tension Soft Start (On/Off), Switched Soft Start (On/Off), Change Speed Trip Point (Set +/- increments of 0.1 units), Setup Tension Trip Point (Select caret position on analog meter display), Change Soft Start Delay (Set +/- increments of 0.1 sec), Change Soft Start Output (+/- increments of 0.1%)
  - **Ratio Setup** – Change Ratio Multiplier (+/- increments of 0.1), Change Ratio Delay (+/- increments of 0.1 sec), Change Ratio Target Output (Output, Setpoint, Line speed)
  - **TLS Setup** – Change TLS Low Mode (Off, Momentary, Latched), Change TLS High Mode (Off, Temporary, Latched), Setup TLS Low Setpoint (Select caret position on analog meter display), Setup TLS High Setpoint (Select caret position on analog meter display), Change TLS Delay (+/- increments of 0.1 sec), Change Tension Off by TLS Low (Yes, No), Change Tension Off by TLS High (Yes, No)
  - **Inputs Setup** – Change Auto Setpoint via (Front Panel, Potentiometer, 0-10V input), Change Manual Setpoint via (Front Panel, Potentiometer, 0-10V input), Change External Tension Toggle (Off/ On), Change External Auto/Manual Toggle (Off/ On)
  - **Control Output Setup** – Change Positive Output Limit (+/- increments of 0.1%), Change Negative Output Limit (+/- increments of 0.1%), Change Control Output (Standard, Reverse)
  - **Relay Function** – Change Relay Function (None, Tension On, TLS On, TLS Off)



- **Communications** – Comm Option (None, Modbus, HCl), Change HCl Address (1-9, A-Z), Change Modbus Address (+/- increments of 1), Change Modbus Baud Rate (4800, 9600, 14400, 19200), Change Modbus Parity (None, Odd, Even), Change Modbus Stop Bits (1 or 2)
2. **CALIBRATION MENU** - Under the Calibration Menu, the following choices are available:
    - **Calibrate** – Setup - Select Units (lb, oz, g, kg, N), Setup - Select Range (Swipe to select from 1, 3, 5 . . . 3000, 4000, 5000), Setup – Select Tension Source (Transducers, RTA-1 [Remote Tension Amplifier 1], RTA-2 [Remote Tension Amplifier 2]), Setup - Select Transducer Type (Auto, Standard, Extended "XR"), Setup – Calibration Weight % (10% of Range, 25% of Range, Other), Setup – Review Settings (Presents selected Units, Range, Calibration Weight % and Transducer Type for review), Zero Transducers
    - **Zero Transducers** – Setup Zero Tension (Press OK when ready to zero.)
    - **Tune PID Values** – Follow procedure in section 5.4 PID TUNE VIEW
    - **Diameter Compensation** – Diameter Comp (On/Off), Full Roll PID Values (Set according to PID TUNE VIEW instructions in section 5.4)
    - **Acceleration Compensation** – Accel Comp Enable (Off/ On), Change Acceleration % (+/- increments of 0.1%), Change Acceleration Limit (+/- increments of 0.1 units), Change Accel P Multiplier (+/- increments of 0.1), Change Accel I Multiplier (+/- increments of 0.1), Change Accel D Multiplier (+/- increments of 0.1)
    - **Tension Filter Time** – Change Tension Filter Time (scroll through pre-selected values from 0.000 sec to 1.000 sec)
  3. **DIAGNOSTIC MENU** - Under the Diagnostic Menu, the following choices are available (All are Read Only, and are useful for discussions with DFE Tech Support), with all other choices greyed out:
    - **Version Menu** - Displays versions and revisions of the software and hardware
    - **Read Digital Inputs** - Displays digital input signals
    - **Read Analog Inputs > Transducer** - Displays analog input signals from the transducers
    - **Read Analog Inputs > Signal Inputs** - Displays analog input signals from other than the transducers

## 5.4 PID TUNE VIEW

The **PID Tune View** screen (Fig. 5-3) is a function-screen that deserves special attention due to its usefulness and somewhat greater complexity than other function-screens. The PID Tune View screen is based off of the **Trend Line Display**, described in Section 1.2, of the Operating Instructions Section of this manual. The display allows viewing the real time Tension, Setpoint and Output in line graph form. The PID Tune View screen adds the capability of real time Proportional, Integral and Derivative tuning adjustments. It can be accessed from the *Calibration Menu > PID Values* menu for the standard (Core) PID values, or from the *Calibration Menu > Diameter Compensation* menu for the Full Roll PID values when using Diameter Compensation (see Section 8.5, Diameter Compensation).



**Figure 5-3 – PID TUNE VIEW SCREEN**

All adjustments are made by tapping directly on the touch screen on any of the listed values on the line above the bottom row of buttons. Tap either P, I, D, Auto or Man to highlight the adjustable parameter you'd like to change. The highlighted term will appear in yellow. Or you may press the SELECT key to cycle through and highlight the adjustable parameter of interest. Once your chosen parameter is highlighted, tap anywhere on the screen above to invoke a minus sign (-) and a plus sign (+) which can be tapped to change the numeric value of the term that is highlighted.

# 6 CALIBRATION

## 6.1 TENSION CALIBRATION

When using the standard transducer connection (as opposed to an RTA input), tension calibration must be completed before the controller is able to display or control tension.

### 1. Standard Transducer Calibration

In preparation for transducer calibration, select an appropriate calibration weight. Larger weights (in reference to the full scale range) tend to give more accurate calibration, but can be unwieldy for large tension ranges. The controller requires a minimum calibration weight of 10% of the full scale range. Get a length of rope, wire, or cable of appropriate length. It must NOT be extensible (stretchy). This will cause inaccurate calibration.

Before calibrating the unit, verify that the factory preset tension units are set to the values you prefer. Tap the **Menu** key. Tap the **Calibrate** tab. From this **Setup – Select Units** screen (Fig.6-1) your choices are lb, oz, g, kg, or N. Select your choice. Press OK.

From this **Setup-Select Range** screen, (Fig. 6-2) verify the Tension Range. This is typically factory-configured, and rarely needs to be changed. If the Tension Range is incorrect, however, swipe to and select the correct range for your application and press OK.

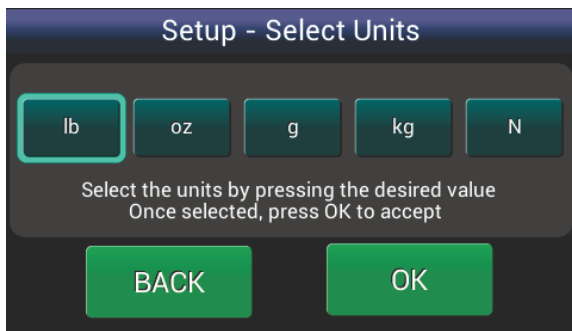


Figure 6-1 – SELECTION OF TENSION UNITS

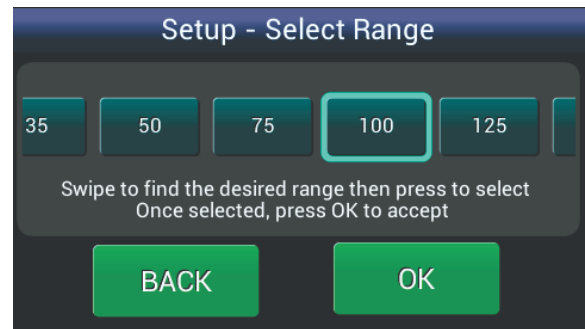


Figure 6-2 – SELECTION OF TENSION RANGE

From the **Setup-Select Tension Source** screen (Fig. 6-3), select either Transducers, RTA-1 or RTA-2, depending on which input you are calibrating at this time.

Select the calibration weight percentage on the Setup-Calibration Weight % screen (Fig. 6-4). Selecting 10% allows use of lighter weights for higher tension applications, and 25% delivers better resolution. Selecting Other conveniently allows for use of a weight which is other than 10% or 25% of the selected tension range, but may not be less than 10%. Locate appropriate weight(s) to use in the calibration step further on in this procedure. Press BACK to return to the prior screen or OK to accept and proceed.

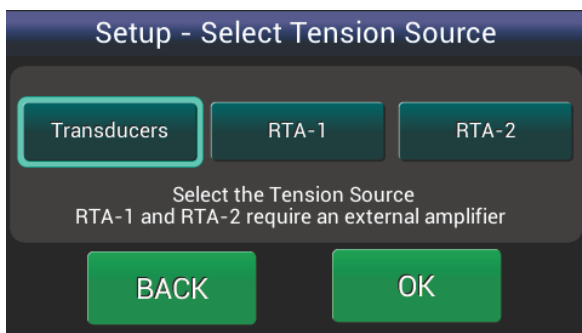


Figure 6-3 – SELECTION OF TENSION SOURCE

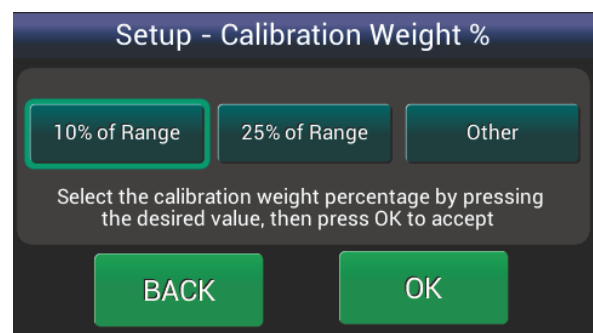
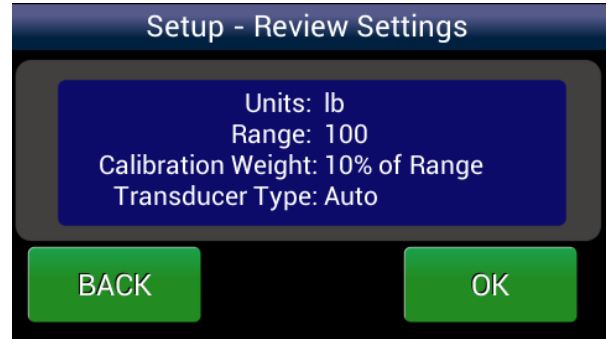
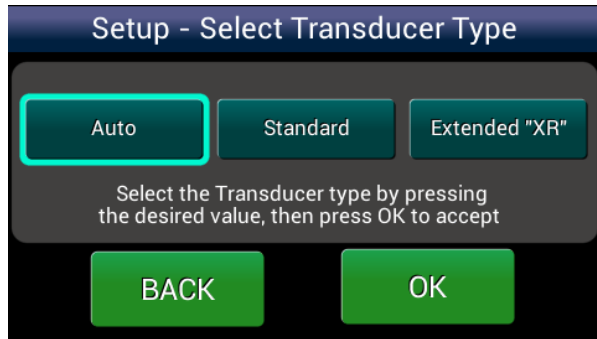


Figure 6-4 – SELECTION OF CALIBRATION WEIGHT

Select the transducer type on the **Setup-Select Transducer Type** screen (Fig. 6-5). Choose Auto if you want the controller to automatically detect the Voltage inputs for your connected transducers, or Standard (5V) unless your Transducers are Marked "XR" (or 10V). Press BACK to return to the prior screen or OK to accept and proceed.

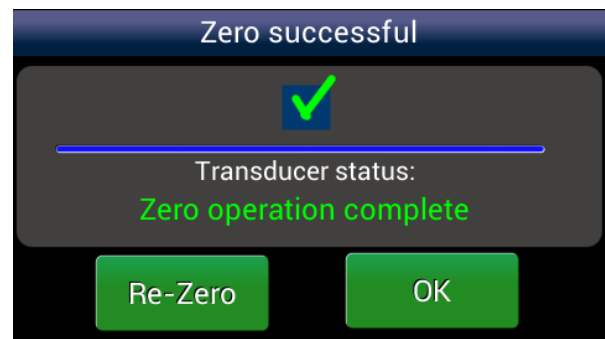
Review settings for correctness on the **Setup-Review Settings** screen (Fig. 6-6), then press OK to accept and proceed or BACK to return to the prior screen.



**Figure 6-5 – SELECTION OF TRANSDUCER TYPE**     **Figure 6-6 – REVIEW OF CALIBRATION SETTINGS**

Per the **Zero Transducers** screen (Fig. 6-7), check the transducer roll to make sure that nothing is hanging from, resting on, or leaning against it, including the calibration rope. Press OK when the roll is unloaded and ready to zero, or BACK to return to the prior screen.

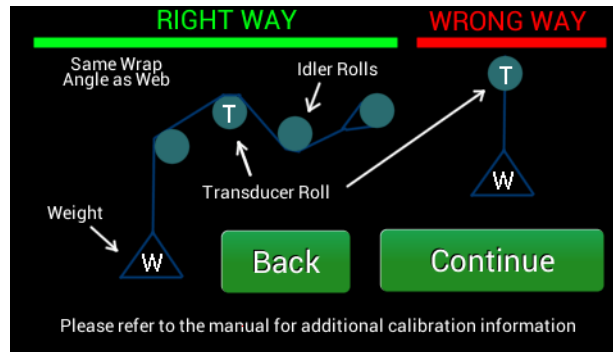
After pressing OK, the SteadyWeb 6™ zeros out the roll weight and a progress bar moves across the screen, after which the message "Zero operation complete" comes up in green characters, as shown on the **Zero successful** screen (Fig. 6-8). Press OK to accept or Re-Zero if anything occurred which made the zero operation suspect.



**Figure 6-7 – ZERO TRANSDUCERS SCREEN**

**Figure 6-8 – ZERO OPERATION COMPLETE**

At the center of the web path (located with a tape measure), secure one end of the inelastic cord to a fixed point at least two rolls beyond the transducer roll, and thread it around the transducer roll and both adjacent idler rolls, following the exact same path as the web which will be measured. See the Right Way / Wrong Way illustration (Fig. 6-9) for guidance.



**Figure 6-9 – WEB PATH FOR CALIBRATION**

Be sure that the cord does not wrap around any driven rolls, drag bars or other obstacles that might affect tension.

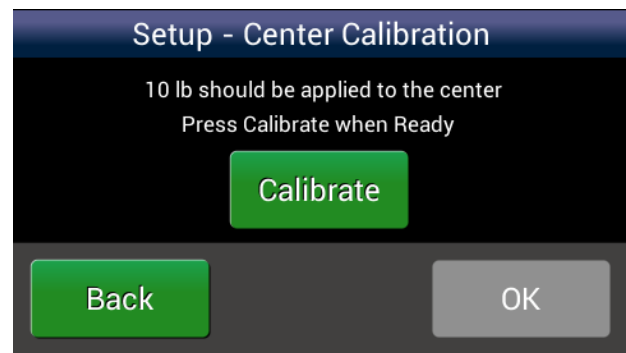
Hang the total calibration weight on the free end of the cord and wait for it to stop swinging. It is important that the cord wrap around one idler roll on either side of the transducer roll, and that the weight be hanging freely, and not be touching anything. When these conditions are satisfied, press Continue to proceed.

Fig. 6-10 shows the **Cal NOT Ready** screen. The Calibrate button is gray, accompanied by an error message in red characters. This error message appears if the transducers are not properly wired to the indicator, if the calibration weight is insufficient for the application, or if the weight is not properly loading the transducer roll.

The Calibrate button will turn green and the red text will disappear when the conditions required for calibration have been met (Fig. 6-11).



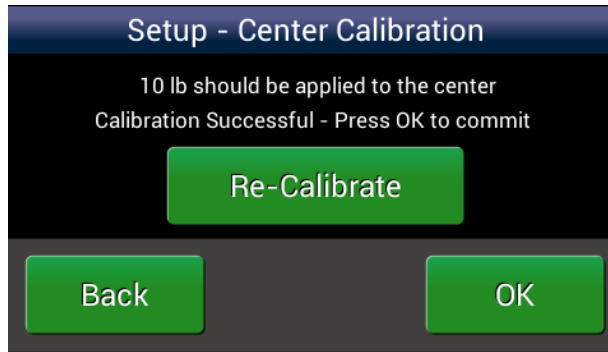
**Figure 6-10 – CAL NOT READY**



**Figure 6-11 – CAL READY**

When ready, press the Calibrate button and the screen will indicate that the calibration was successful (Fig. 6-12). Press BACK to return to the prior screen; Re-Calibrate if something occurred which made the calibration suspect, or OK, after which the indicator will very briefly flash a Calibration Successful screen, and then progress to the **Display** Screen.

If the calibration was unsuccessful and an error message is returned, refer to Section 11.2 for error message meanings.



**Figure 6-12 – CAL SUCCESSFUL**

## 6.2 REMOTE TENSION AMPLIFIER CONFIGURATION

Follow the instruction manual provided with the remote tension amplifier or indicator to calibrate the system. The 0-10V signal from the amplifier should be wired to Terminal Block 4 (TB4) on the controller board, to the RTA 1 and RTN 1 or RTA 2 and RTN 2 terminals (see Figure 4-10).

Use the **Menu** key to put the display in Menu display mode. Navigate to the *Setup Menu > Tension Control Setup* menu and adjust the **Tension Source** menu item to RTA 1 or RTA 2, based upon which pair of RTA inputs are being utilized.

Navigate to the *Calibration Menu* and adjust the **Tension Range** as required for your application. A 10V signal from the remote tension amplifier will correspond to the value specified by the **Tension Range** setting. No controller calibration is necessary when using the RTA input.

## 6.3 LINE/ROLL SPEED INPUT CALIBRATION

The Line Speed represents the actual speed of the web and is useful for Line Speed Follow modes of control, as well as for tachometer ratio diameter calculation. It is usually determined by a tachometer reading an idler roll's spinning rate.

The Roll Speed represents the speed of a rotating roll, either in an Unwind or Rewind system. It again, is typically determined by a tachometer signal measuring the roll's spinning rate. The Roll Speed is used together with the Line Speed to calculate a roll's diameter (see Section, 6.5 Diameter Input Calibration, for more information).

There are three ways to feed a Line or Roll speed signal to the SteadyWeb 6™ controller:

- A 0-10 VDC signal from an external calibrated tachometer or device where 0 Volts represents zero speed and 10 Volts represents full speed.
- A 0-250 VDC signal representing speed from an external DC Tachometer.
- A 1-50 VDC pulsed signal representing speed from an external Pulse Tachometer Encoder.

### 1. 0-10V Signal

When using a 0-10V signal, no calibration is necessary. The signal should be wired directly into the control board's Signal terminal block (see Figure 4-10). A Line speed signal should be wired into (TB3) terminal 19 (LINE IN) and 21 (GROUND) and a Roll Speed input should be wired into (TB3) terminal 20 (ROLL IN) and 22 (GROUND) (see Figure 4-10).

For Line speed inputs, the **Max Line Speed** setting in the *Setup Menu > Line Speed Setup* menu should be set to the line speed represented by 10V on the LINE\_IN input terminal. The **Line Speed Units** setting should be set to the desired line speed display units.

## 2. DC Tachometer Input

Input from a DC Tachometer requires a DC Tachometer Input option card (P/N 723-2085). For a Line Speed input, this card must be installed into the LINE TACH slot on the control board (plugging into P4) and mounted properly to the two supportive mounting studs (see Figure 4-12, Option Card Mounting Locations). For a Roll Speed input, the card must be installed into the ROLL TACH slot on the control board (plugging into P5) and mounted properly to the two supportive mounting studs (see Figure 4-12, Option Card Mounting Locations).

For instructions on how to calibrate the DC Tachometer input option card, refer to Section 6.3, DC Tachometer Calibration.

If calibrating the Line Speed input, the **Max Line Speed** setting in the *Setup Menu > Line Speed Setup* menu should be set to the maximum Line Speed value and the **Line Speed Units** setting should be set to the desired line speed display units.

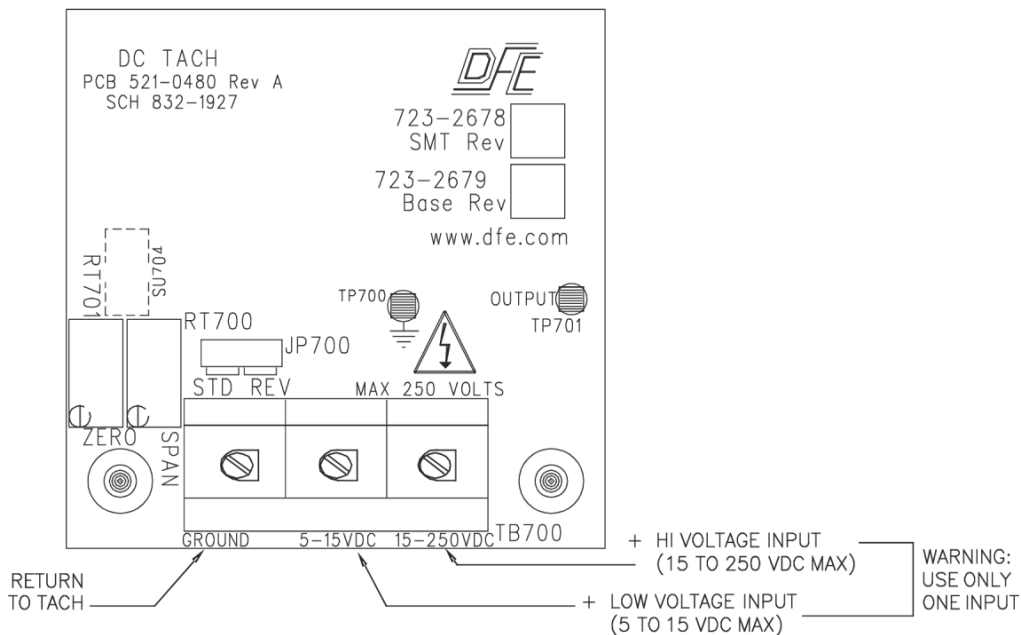
## 3. Pulse Tachometer Input

Input from a Pulse Tachometer requires a Pulse Tachometer input option card (P/N 723-2084). For a line speed input, this card must be installed into the LINE TACH slot on the control board (plugging into P4) and mounted properly to the two supportive mounting studs (see Figure 4-12, Option Card Mounting Locations). For a roll speed input, the card must be installed into the ROLL TACH slot on the control board (plugging into P5) and mounted properly to the two supportive mounting studs (see Figure 4-12, Option Card Mounting Locations).

For instruction on how to calibrate the Pulse Tachometer input option card, refer to section 6.4, Pulse Tachometer Calibration.

If calibrating the Line speed input, the **Max Line Speed** setting in the *Setup Menu > Line Speed Setup* menu should be set to the maximum Line speed value and the **Line Speed Units** setting should be set to the desired line speed display units.

## 6.4 DC TACHOMETER CALIBRATION



**Figure 6-13 - DC TACHOMETER CARD**

The optional DC Tachometer input card accepts a DC input voltage from a tachometer with a maximum output voltage between 5 and 250 VDC and converts it to a 0-10 VDC signal which gets passed down to the controller board. The 0-10 VDC Tachometer card output signal ties into the Signal terminal block (TB3) input terminals, either terminal 19 (LINE IN) when populated in the LINE TACH OPTION CARD slot or terminal 20 (ROLL IN) when populated in the ROLL TACH OPTION CARD slot. For this reason, a 0-10V signal should not be fed to both the control board's Signal terminal block (TB3) LINE IN or ROLL IN terminal and the corresponding tachometer input option card. The Line and Roll signal should only come from a single source, the TB3 terminal block OR a tachometer option card, and the terminal block input should never be used while the corresponding tachometer option card slot is populated with a tachometer card.

For DC tachometers that output a maximum output voltage between 5 and 15 VDC, the positive tachometer output lead should be connected to terminal 2 of the DC Tachometer input card terminal block (TB700). Tachometers with a maximum output voltage between 15 and 250 VDC should connect the positive tachometer output to terminal 3 of the DC Tachometer input card terminal block (TB700). The negative tachometer output should be connected to terminal 1 (GROUND) of the DC Tachometer input card terminal block (TB700) (see Fig. 4-14, DC Tachometer Electrical Connections).

With the tachometer properly wired to the DC Tachometer input card and power applied to the controller, attach the positive clip lead (or probe) of a DC Voltmeter to test point TP701 (OUTPUT) and the negative clip lead (or probe) to test point TP700 (GROUND) on the DC Tachometer input card (see Figure 6-13, DC Tachometer Card).

With the machine at zero speed, the output at the Voltmeter should read 0.0V. If not, adjust the RT701 (ZERO) potentiometer until the output voltage reads 0.0V. (see Figure 6-13, DC Tachometer Card). Run the machine at max speed, or optionally at 50% max speed and note the polarity of the output at the Voltmeter. If the polarity is negative, swap the location of jumper JP700 from STD (standard) to REV (reverse) (see Figure 6-13, DC Tachometer Card).



Use a hand tachometer to verify the machine is running correctly at maximum speed (or at 50% speed if desired).

Next, the RT700 (SPAN) potentiometer must be adjusted on the DC Tachometer input card to create the desired output at the Voltmeter (see Figure 6-13, DC Tachometer Card). When calibrating a Line Speed tachometer or a Roll tachometer at core diameter, the SPAN potentiometer should be adjusted to match the machine speed. For example, if running the machine at max speed, the SPAN potentiometer should be adjusted for a 10.0V output at the Voltmeter. If running the machine at 50% speed, the SPAN potentiometer should be adjusted for a 5.0V output

If you are calibrating a Roll tachometer and there is some material on the core, measure the roll diameter and adjust the SPAN potentiometer to produce a test point voltage of:

**10 x (core diameter / actual diameter)** for max speed or  
**5 x (core diameter / actual diameter)** for 50% speed

Once calibrated, decrease and increase the machine speed and verify the DC Tachometer input card output follows machine speed changes. Stop the machine and verify the output drops down to 0.0V. If the output does not read 0.0V with the machine stopped, adjust the ZERO offset potentiometer (RT701) to bring the output to 0.0V and repeat the calibration steps for max speed as described above.

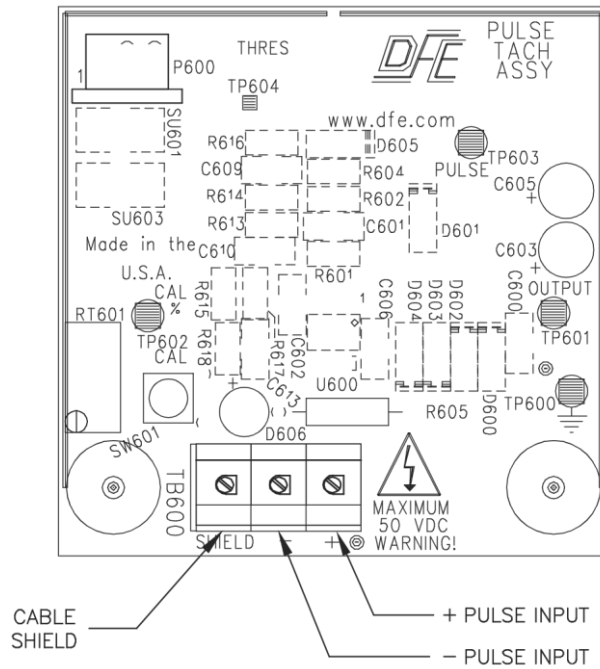
**NOTICE** If the OUTPUT and GROUND test points (TP701 and TP700) are difficult to access, the tachometer option card output signal can be read from the control board Signal terminal block (TB3) connections; terminal 19 (LINE IN) and 21 (GROUND) for the Line Speed tachometer card output and terminal 20 (ROLL IN) and 22 (GROUND) for the Roll Speed tachometer card (see Section 4.11, Standard Electrical Connections).

If calibrating the Line speed input, the **Max Line Speed** setting in the *Setup Menu > Line Speed Setup* menu should be set to the line speed represented by 10V on the tachometer option card output. The **Line Speed Units** setting should be set to the desired line speed display units.

## 6.5 PULSE TACHOMETER CALIBRATION

The optional Pulse Tachometer input card accepts a pulsed tachometer output signal with a peak output voltage that falls within 1 to 50V. While the peak output voltage of the tachometer is not important (as long as it is under 50V) the low voltage must come close to 0V for an accurate pulse reading. The Pulse Tachometer option card converts the pulsed signal to a 0-10V signal which gets passed down to the controller board. The Pulse Tachometer card output signal ties into the control board's Signal terminal block (TB3), either terminal 19 (LINE IN) when populated in the LINE TACH OPTION CARD slot or terminal 20 (ROLL IN) when populated in the ROLL TACH OPTION CARD slot. For this reason, a 0-10V signal should not be fed to both the Signal terminal block (TB3) LINE IN or ROLL IN terminal and the corresponding tachometer input option card. The Line and Roll signal should only come from a single source, the TB3 terminal block OR a tachometer option card, and the terminal block input should never be used while the corresponding tachometer option card slot is populated with a tachometer card.

The positive output of the pulse tachometer should connect to terminal 3 (+) of the Pulse Tachometer input card terminal block (TB600). The negative output of the pulse tachometer should connect to terminal 2 (-) of the Pulse Tachometer Input card terminal block (TB600) (see Section 4.13, Pulse Tachometer Option Card Electrical Connections).



**Figure 6-14 - PULSE TACHOMETER CARD**

With the tachometer properly wired to the Pulse Tachometer input card and power applied to the controller, attach the positive clip lead (or probe) of a DC Voltmeter to test point TP602 (CAL) and the negative clip lead (or probe) to test point TP600 (GROUND) on the Pulse Tachometer input card (see Figure 6-14).

When calibrating a Line speed tachometer or a Roll tachometer at core diameter, the CAL potentiometer (RT601) should be adjusted to match the machine calibration speed, which is typically max speed or 50% max speed (see Figure 6-14). For example, if you are calibrating your machine at max speed, adjust the CAL voltage at the Voltmeter to 10.0V. If you are calibrating your machine at 50% speed, adjust the CAL voltage at the Voltmeter to 5.0V.

If you are calibrating a Roll tachometer and there is some material on the core, measure the roll diameter and adjust the CAL potentiometer to produce a test point voltage of:

- 10 x (core diameter / actual diameter)** for max speed or
- 5 x (core diameter / actual diameter)** for 50% speed

Once the CAL voltage has been adjusted, run the machine at max speed, or optionally at 50% max speed, corresponding to the CAL voltage. Use a hand tachometer to verify that the machine is running correctly at maximum speed (or at 50% speed if desired) and press the CAL push button (SW1) (see Figure 6-14). This will cause the Pulse Tachometer Input card to sample the current pulse rate and adjust the output voltage to match the voltage set by the CAL potentiometer (RT601). The Pulse Tachometer option card's LED will flash briefly at the beginning of the calibration sequence and flash again when the calibration sequence is complete. This may take a few seconds, and slower pulse rates generally take a longer period of time to calibrate than faster pulse rates. When calibration is complete, the LED will go back into run mode, flashing each time a pulse is received. Under normal operation, the LED will look to be on solid because of the high pulse frequency. If the LED is off completely and not flashing, the card is not detecting pulses from the tachometer. Depending on the full range frequency,

the LED may flash at a slower rate than once per pulse. If the full range frequency is greater than 3,125Hz, for example, the LED will flash every 4 pulses. If the full range frequency is greater than 12.5kHz, the LED will flash every 16 pulses. Typically, however, the pulse rate will cause the LED to be flashing too fast to distinguish individual pulses and will appear to be steady on.

After the calibration sequence is complete, move the positive clip lead (or probe) of the Voltmeter to test point TP701 (OUTPUT) and verify the output of the Pulse Tachometer Input card matches the voltage that was previously set with the CAL potentiometer (RT601). Decrease and increase the machine speed and verify the Pulse Tachometer Input card output voltage follows speed changes. Stop the machine and verify the output voltage drops to 0.0V.

**NOTICE** If the OUTPUT and GROUND test points (TP601 and TP600) are difficult to access, the tachometer option card output signal can be read from the control board Signal terminal block (TB3) connections; terminal 19 (LINE IN) and 21 (GROUND) for the Line Speed tachometer card output and terminal 20 (ROLL IN) and 22 (GROUND) for the Roll Speed tachometer card (see Section 4.11, Standard Electrical Connections).

If calibrating the Line speed input, the **Max Line Speed** setting in the *Setup Menu > Line Speed Setup* menu should be set to the line speed represented by 10V on the tachometer option card output. The **Line Speed Units** setting should be set to the desired line speed display units.

## 6.6 DIAMETER INPUT CALIBRATION

There are two ways to feed a diameter signal to the SteadyWeb 6™ controller.

- Directly from a diameter measurement device, such as from a rider assembly or ultrasonic sensor.
- As an internally calculated diameter based on the ratio of the Line speed to Roll speed inputs. This mode requires valid Line and Roll speed inputs, which may need to be individually calibrated (see section 6.2, Line/Roll Speed Input Calibration).

### 1. Direct Diameter Input

The Diameter input is designed to take a signal from a rider assembly, ultrasonic sensor or other diameter measurement device that has an output that falls between 0 and 10 VDC. The minimum voltage variation between core diameter and full roll diameter should cause at least 4V of change. When using a rider assembly, ensure the rider moves freely over the entire range of roll diameters. When using an ultrasonic sensor, ensure the ultrasonic beam is aimed perpendicular to the winding roll, not at an angle.

The diameter signal should be wired directly into the control board's Signal terminal block (TB3) terminal 23 (DIA IN) and 21 (GROUND) (see Section 4.11, Standard Electrical Connections). An available +10V or 15V power supply is available for driving light loads such as a roll follower potentiometer or ultrasonic range finder (see Section 4.9, Customer +10/15V Output Selection).

To set the diameter input type, navigate to the *Setup Menu > Diameter Setup* menu and set the **Diameter Input Type** setting to **Direct**. In the same menu, adjust the **Core Diameter**, **Max Full Roll Dia** and **Diameter Units** settings to the values required for your application.

Select the **Calibrate Rider** function to calibrate the diameter measurement device. The Calibrate Rider function will first ask you to calibrate the core diameter. Place an empty core in the machine and lower the roll follower or activate the range finder and press CAL. The "SAVING..." message screen will appear for approximately one second while the controller stores the core diameter input value.

Next, the controller will ask you to calibrate the full roll diameter. Load a roll on the machine with the maximum used diameter. Lower the roll follower or activate the range finder and press CAL. The “SAVING...” message screen will appear again for approximately one second while the controller stores the full roll diameter input value. Upon successful calibration, the **Calibrate Rider** function exits back to the *Setup Menu > Diameter Setup* screen. If the calibration was unsuccessful and an error message is returned, refer to Section 9.2 for error message meanings.

## 2. Direct Diameter Input Using a DC Tachometer Card

If the Diameter input is fed from a diameter measurement device that outputs more than 10 VDC, a DC Tachometer Option Card may be used to convert the voltage to a 0-10V signal (P/N 723-2085). For such a situation, the card should be installed into the ROLL TACH slot on the control board (plugging into P5) and mounted properly to the two supportive mounting studs (see Figure 4-12, Option Card Mounting Locations). The output of the tachometer card can then be tied from the Signals terminal block (TB3) terminal 20 (ROLL IN) to the diameter input, terminal 23 (DIA IN), with a short piece of jumper wire. See Section 6.3, DC Tachometer Calibration, for instructions on calibrating the DC Tachometer.

## 3. Tachometer Ratio Calculation

Tachometer ratio calculation determines the roll diameter by monitoring the ratio of the Line Speed to Roll Speed inputs and taking into consideration that as diameter increases, a slower rotation is required for a given speed. For example, if the Roll input signal is half that of the Line input signal, the diameter of the Roll will be twice that of the core diameter.

To set the diameter input type, navigate to the *Setup Menu > Diameter Setup* menu and set the **Diameter Input Type** setting to **Tach Ratio Calc**. In the same menu, adjust the **Core Diameter**, **Max Full Roll Dia** and **Diameter Units** settings to the values required for your set up.

To use the Tachometer Ratio Calculation feature, Line and Roll inputs must be present and calibrated if required (see section 6.2, Line/Roll Speed Input Calibration).

## 4. Testing the Diameter Measurement

In the *Operator Menu > Display Configuration* menu, set the **Diameter Display** setting to **On**. This will display diameter information in the tension display screens in circular graph form, as well as text readout for both diameter percentage and the diameter value (based upon the **Core Diameter**, **Max Full Roll Dia** and **Diameter Units** settings).

The diameter displayed should differ with the actual measured diameter by no more than 10% and preferably 5%. If this is not the case, re-perform calibration as described above.

# 6.7 SIGNAL FILTERING

The tension, diameter and line/roll inputs all feature adjustable input filtering. These are rolling average filters used to filter high frequency noise. Greater filter times allow for a cleaner signal with the drawback of added delay.

## 1. Tension

The tension filter action is determined by the **Tension Filter Time** setting, located in the Calibration Menu. Increasing the filter time can help filter high frequency noise, such as caused by machine vibration. The added delay that comes with increasing the filter time, however, can increase instability in the control loop (see Section 8, Tuning Adjustments). This setting should NOT be used to make the tension reading more readable in a tension display screen. There is a separate display tension damping filter in the *Operator Menu > Display Configuration* menu that can be used to adjust the visual,

displayed tension filter without affecting the tension reading used by the control loop (see Section 9.2, Display Adjustments).

## 2. Diameter

The diameter filter action is determined by the **Diameter Filter Time** setting, located in the *Setup Menu* > *Diameter Setup* menu. Increasing the filter time can help filter high frequency diameter noise, such as caused by an out of round roll. As the diameter signal is typically a very slow changing signal, this filter time can be set reasonably high without having a negative effect on control.

## 3. Line / Roll

The Line and Roll Inputs share a common filter time setting. Increasing the filter time for one will do the same for the other. The only time the Roll Input is used is in conjunction with the Line Input for tachometer ratio diameter calculation, and so sharing a common filter ensures that both signals are equally filtered in such applications. It should be noted that when using tachometer ratio diameter calculation mode of diameter input, the diameter filter applies to the calculated diameter value. This means that there are essentially two separate filters involved in the diameter signal reading in such applications, the Line / Roll Filter and the Diameter Filter.

This filter can play an important role in controllers using a Line Speed Follow mode of operation, where noise in the Line Signal gets carried over into the output signal. Increasing the filter time helps reduce the impact of this noise, but also increases the delay to a fast-changing Line Signal. Some experimentation may be required in setting the filter time to find optimal controller performance.

# 7 SETUP

---

## 7.1 CONTROL FEEDBACK MODES

The controller features three Control Feedback Modes. The mode of use is specified by the **Control Feedback** setting, located in the *Setup Menu > Tension Control Setup* menu. The three feedback modes are **Standard Closed Loop**, **Line Speed Follow Tension Trim** and **Diameter Compensated Line Speed Follow Tension Trim**.

### 1. Standard Closed Loop

Standard Closed Loop control is used for standard tension control applications. The output is adjusted to maintain tension at the operator selected setpoint. The only input required for Standard Closed Loop control is a tension signal, either directly from transducers or through one of the RTA (Remote Tension Amplifier) inputs.

### 2. Line Speed Follow Tension Trim

Line Speed Follow Tension Trim mode of control is typically used in Intermediate Zone applications to prevent a lag in the output during Line Speed changes. The output is set to mirror the web speed, varying only by a small percentage to maintain tension. Line Speed Follow Tension Trim requires a Line Speed input (see Section, 6.2 Line/Roll Speed Input Calibration). In Intermediate Zone applications where the tension transducer is positioned after the drive motor the **Control Output** parameter should be set to **Reverse** (see Section 4.6 Control Output Selection).

When Line Speed Follow Tension Trim mode of control is utilized, the **Tension Trim** and **Trim Percentage Target** settings, both located in the *Setup Menu > Tension Ctrl Setup* menu, control the degree of tension trim. The **Tension Trim** setting is programmed as a percentage value representing the percentage of **Output OR Line Speed**, as specified by the **Trim Percentage Target** setting, for which tension should be trimmed. For example, setting Tension Trim to 10% and Trim Percentage Target to Output will cause the output to match the 0-10V Line speed signal with +/- 1V of tension trim. Setting Tension Trim to 10% and Trim Percentage Target to Line Speed, on the other hand, will cause the output to match the 0-10V Line speed signal with +/-10% of that signal of tension trim. If the Line speed signal is at 1V, for example, there is +/- 0.1V of tension trim. If the Line speed signal is at 10V, there is +/- 1V of tension trim. Using the Line Speed target prevents the tension trim percentage from dominating the output contribution at low Line speeds, which can be preferable in certain applications.

### 3. Diameter Compensated Line Speed Follow Tension Trim:

Diameter Compensated Line Speed Follow Tension Trim control is similar to Line Speed Follow Tension Trim with the exception of being used in rewind applications. The control output is set to mirror web speed, varying only by a small percentage to maintain tension, while taking into consideration the diameter of the rewind roll. As the roll diameter increases, a single rotation will wrap more web material and so a given rotational speed will lead to faster web speed. To account for this, the controller decreases the output as the roll diameter increases to maintain the desired web speed. This mode of operation requires both a line speed and a diameter input (see Section, 6.2 Line/Roll Speed Input Calibration and Section 6.5, Diameter Input Calibration). The degree of tension trim is determined by the **Tension Trim** and **Trim Percentage Target** settings, as described above in the Line Speed Follow Tension Trim description.

## 7.2 UNWIND ZONE SETUP

The following series of steps are provided to setup the controller for use in an Unwind zone.

1. Set the **Tension Zone** setting to **Unwind**. This setting is located in the *Setup Menu > Tension Ctrl Setup* menu.
2. Ensure the **Control Feedback** setting is set to **Closed Loop**. This setting is located in the *Setup Menu > Tension Ctrl Setup* menu. See Section 7.1, Control Feedback Modes, for more information.

**Q:** What type of Actuator device will you be feeding?  
**A:** Motor Drive.  
Assuming a typical motor drive with a +/-10V input, configure the controller for voltage output with a full bipolar range (-100% to 100%) and set the **Control Output** setting to **Reverse**. See Section 4.6, Control Output Selection.

**Q:** What type of Actuator device will you be feeding?  
**A:** Brake  
Configure the output for 0-10V or 4-20mA as required to drive your brake configuration. If ordered as a Version P, use the 4-20mA output to the pneumatics module. Ensure the **Control Output** setting is set to **Standard**. See Section 4.6, Control Output Selection.

**Q:** Will you be using the Soft Start feature? This feature is commonly used in Unwind applications to prevent brake lock up during machine start up. See Section 7.5, Soft Start Setup, for more information.  
**A:** Yes. (Recommended)  
Configure Soft Start as required for your application. See Section 7.5, Soft Start Setup.  
**A:** No.  
Ensure the **Speed Soft Start**, **Tension Soft Start** and **Switched Soft Start** settings are set to Off. See Section 7.5, Soft Start Setup.

**Q:** Will you be using the TLS (Tension Limit Switch) feature? This feature is used to provide an alarm when web tension exceeds or drops below user specified levels. See Section 7.7, Tension Limit Switch Setup, for more information.  
**A:** Yes.  
Configure TLS as required for your application. See Section 7.7, Tension Limit Switch Setup.  
**A:** No.  
Ensure the **TLS Low Mode** and **TLS High Mode** settings are set to Off. See Section 7.7, Tension Limit Switch Setup.
3. If not already completed, calibrate tension as described in Section 6.1, Tension Calibration.
4. Tune the control loop as specified in Section 8, Tuning Adjustments. In applications with a large difference between core and full roll diameter, the Diameter Compensation feature may be useful. In this case, a diameter input signal is required, see Section 6.5, Diameter Input Calibration.
5. Configure the tension display as described in Section 2.2, Display Adjustments, to your personal preferences.
6. Once the controller is set up, tuned and operating as desired, save the Setup and tuning parameters as described in Section 2.3, Saving and Recalling Setups

## 7.3 INTERMEDIATE ZONE SETUP

The following series of steps are provided to setup the controller for use in an Intermediate zone.

1. Set the **Tension Zone** setting to **Intermediate**. This setting is located in the *Setup Menu > Tension Ctrl Setup* menu.

**Q:** Is the tension measurement transducer positioned before or after the driven nip?

**A:** Before.

Assuming a typical motor drive with a +/-10V input, configure the controller for voltage output with a full bipolar range (-100% to 100%) and ensure the **Control Output** setting is set to **Standard**. See Section 4.6, Control Output Selection.

**A:** After.

Assuming a typical motor drive with a +/-10V input, configure the control for voltage output with a full bipolar range (-100% to 100%) and set the **Control Output** setting to **Reverse**. See Section 4.6, Control Output Selection.

**Q:** Will you be using the **Line Speed Follow Tension Trim** mode of control, as is typical in intermediate zones? See Section 7.1, Control Feedback Modes, for more information.

**A:** Yes (Recommended)

Set the **Control Feedback** setting to **Line Follow Tension**. This setting is located in the *Setup Menu > Tension Ctrl Setup* menu. See Section 7.1, Control Feedback Modes, for more information. This mode of operation requires a Line speed signal, see Section 6.2 Line/Roll Speed Input Calibration.

**A:** No (May cause lag in output when Line speed changes).

Ensure the **Control Feedback** setting is set to **Closed Loop**. This setting is located in the *Setup Menu > Tension Ctrl Setup* menu. See Section 7.1, Control Feedback Modes, for more information.

**Q:** Will you be using the TLS (Tension Limit Switch) feature? This feature is used to provide an alarm when web tension exceeds or drops below user specified levels. See Section 7.7, Tension Limit Switch Setup, for more information.

**A:** Yes.

Configure TLS as required for your application. See Section 7.7, Tension Limit Switch Setup.

**A:** No.

Ensure the **TLS Low Mode** and **TLS High Mode** settings are set to Off. See Section 7.7, Tension Limit Switch Setup.

2. If not already completed, calibrate tension as described in Section 6.1, Tension Calibration.
3. Tune the control loop as specified in Section 8, Tuning Adjustments.
4. Configure the tension display as described in Section 2.2, Display Adjustments, to your personal preferences.
5. Once the controller is set up, tuned and operating as desired, save the Setup and tuning parameters as described in section 2.3, Saving, Recalling and Deleting Setups.

## 7.4 REWIND ZONE SETUP

The following series of steps are provided to setup the controller for use in a Rewind zone.

1. Set the **Tension Zone** setting to Rewind. This setting is located in the *Setup Menu > Tension Ctrl Setup* menu.
2. Assuming a typical motor drive with a +/-10V input, configure the controller for voltage output with a full bipolar range (-100% to 100%) and ensure the **Control Output** setting is set to **Standard**. See Section 4.6, Control Output Selection.

**Q:** Will you be using the **Diameter Compensated Line Speed Follow Tension Trim** mode of control? See Section 7.1, Control Feedback Modes, for more information.

**A:** Yes

Set the **Control Feedback** setting to **Line Follow Diam. Comp**. This setting is located in the *Setup Menu > Tension Ctrl Setup* menu. See Section 7.1, Control Feedback Modes, for more information. This mode of operation requires Line and Roll speed signals (to provide for diameter calculation) see Section 6.2 Line/Roll Speed Input Calibration, OR a Line speed signal and a Diameter input signal, see Section 6.5 Diameter Input Calibration.



**A:** No

Ensure the **Control Feedback** setting is set to **Closed Loop**. This setting is located in the *Setup Menu > Tension Ctrl Setup* menu. See Section 7.1, Control Feedback Modes, for more information.

**Q:** Will you be using the TLS (Tension Limit Switch) feature? This feature is used to provide an alarm when web tension exceeds or drops below user specified levels. See Section 7.7, Tension Limit Switch Setup, for more information.

**A:** Yes.

Configure TLS as required for your application. See Section 7.7, Tension Limit Switch Setup.

**A:** No.

Ensure the **TLS Low Mode** and **TLS High Mode** settings are set to Off. See Section 7.7, Tension Limit Switch Setup

3. If not already completed, calibrate tension as described in Section 6.1, Tension Calibration.

**Q:** Will you be using the Taper feature? This can be used to eliminate common roll defects and produce better quality rolls. See Section 2.5, Taper Tension, for more information.

**A:** Yes.

Set the **Taper Enable** setting to On and adjust the **Taper Percentage** setting to the desired Taper percentage, see Section 2.5, Taper Tension.

**A:** No.

Ensure the **Taper Enable** setting is set to Off, see Section 2.5, Taper Tension.

4. Tune the control loop as specified in Section 8, Tuning Adjustments. In applications with a large difference between core and full roll diameter, the Diameter Compensation feature may be useful. In this case, a diameter input signal is required, see Section 6.5, Diameter Input Calibration.

5. Configure the tension display as described in Section 2.2, Display Adjustments, to your personal preferences.

6. Once the controller is set up, tuned and operating as desired, save the Setup and tuning parameters as described in section 2.3, Saving, Recalling and Deleting Setups.

## 7.5 SOFT START SETUP

Soft Start is normally used only in braked Unwind zone applications and should be left Off when the controller is being used to control Rewind or Intermediate tension. Soft Start is used to reduce the control output to a preset (user-adjustable) low level to prevent brake lockup when the machine starts. Upon exiting Soft Start, the PID loop performs a bump-less transfer back into control mode. In tension display mode, a Soft Start indicator will appear on the display whenever Soft Start is active. Soft Start is only activated when the controller is in Auto mode (not in Manual mode).

Soft Start can be actuated by any of three methods:

- Automatically upon a loss of tension below a preset trip point (after an adjustable delay).
- Automatically by machine speed dropping below the speed trip point (after an adjustable delay).
- Immediately upon closure of an external contact.

It is possible to actuate Soft Start using one or more sources at a time.

### 1. Actuation by Low Tension

Soft Start by Tension is the standard configuration, and requires no extra external electrical connections. To activate, navigate to the *Setup Menu > Soft Start Setup* menu and set the **Tension Soft Start** setting to On.

Within the same menu, set the **Tension Trip Point** setting to the desired Tension Trip point. For example, with a range of 100 lbs and a **Tension Trip Point** setting of 10 lbs, Tension Soft Start will be activated by tension falling below 10 lbs. Avoid setting the trip point close to your operating tension. Typically, it should be set much lower than the operating tension.

Also, within the Soft Start Setup menu, set the **Soft Start Delay** setting to the desired length of time to delay after the tension falls below the **Tension Trip Point** setting and before Soft Start is activated. This eliminates nuisance actuation if the tension drops for only a short time. This delay is only associated with entering Soft Start mode, not leaving it. Tension Soft Start mode is exited immediately upon tension climbing above the Tension Trip Point value. It should be noted that the Soft Start Delay setting is used by both **Tension Soft Start** and **Speed Soft Start**. This means that if using both Soft Start by Tension and Soft Start by Speed, the same delay time will affect the time required to enter both Soft Start modes.

Finally, set the **Soft Start Output Level** to the desired percentage of max output. It is best to set this value low, but high enough to produce enough tension to exceed the **Tension Trip Point** or the controller may become stuck in Soft Start mode. The **Soft Start Output Level** setting is used by all three Soft Start modes.

## 2. Actuation by Line Speed

Soft Start by Line Speed requires a valid Line Speed input signal (see Section 6.2 Line/Roll Speed Input Calibration).

To activate, navigate to the *Setup Menu > Soft Start Setup* menu and set the **Speed Soft Start** setting to On.

Within the same menu, set the **Speed Trip Point** setting to the desired Line Speed trip point. For example, with a range of 1,000 ft/min. and a **Speed Trip Point** setting of 100 ft/min., Speed Soft Start will be activated by Line Speed falling below 100 ft/min. Typically, this value should be set to around 10% of your maximum Line Speed.

Also, within the Soft Start Setup menu, set the **Soft Start Delay** setting to the desired length of time to delay after the Line Speed falls below the **Speed Trip Point** setting and before Soft Start is activated. This eliminates nuisance actuation if the Line Speed drops for only a short time. This delay is only associated with entering Soft Start mode, not leaving it. Line Speed Soft Start mode is exited immediately upon Line Speed climbing above the Speed Trip Point value. It should be noted that the Soft Start Delay setting is used by both **Speed Soft Start** and **Tension Soft Start**. This means that if using both Soft Start by Speed and Soft Start by Tension, the same delay time will affect the time required to enter both Soft Start modes.

Finally, set the **Soft Start Output Level** to the desired percentage of max output. It is best to set this value low, but high enough to produce enough tension to produce a smooth takeoff. The **Soft Start Output Level** setting is used by all three Soft Start modes.

## 3. Actuation by External Contact Closure

To activate, navigate to the *Setup Menu > Soft Start Setup* menu and set the **Switched Soft Start** setting to **On**. Connect an external switch or relay contact to the Signals terminal block (TB3) terminal 13 (SOFT) and terminal 11 (GROUND) (see Section 4.11, Standard Electrical Connections). The controller will enter Soft Start mode immediately upon closure of the switch and will remain in Soft Start mode as long as the contact is closed.

Finally, set the **Soft Start Output Level** to the desired percentage of max output. The **Soft Start Output Level** setting is used by all three Soft Start modes.

## 7.6 SAMPLE AND HOLD / RATIO SETUP

The controller features a Sample and Hold input as well as a Ratio input. Both are actuated by closure of an external switch or relay. The Ratio feature can be useful in basic unwind splicing operations to quickly adjust the output from the level produced at core to a level appropriate for a full roll.

### 1. Sample & Hold

For Sample & Hold functionality, wire an external switch or relay contact to the Signals terminal block (TB3) terminal 10 (HOLD) and terminal 12 (GROUND) (see Section 4.11, Standard Electrical Connections). Upon contact closure, the controller will sample the current output and hold it at that level until the contact is opened, at which time the PID control loop will perform a bump-less transfer back into control mode.

### 2. Sample & Hold / Ratio

For Ratio functionality, wire an external switch or relay contact to the Signals terminal block (TB3) terminal 9 (RATIO) and terminal 11 (GROUND) (see Section 4.11, Standard Electrical Connections).

The Ratio function can act upon 1 of 3 possible targets; the **Output**, the **Setpoint**, or the **Line Speed**, and its functionality differs somewhat depending on the specified target. When set to **Output**, the Ratio function will sample the current output value upon contact closure, multiply that by the **Ratio Multiplier** value and hold that multiplied value until the contact is opened and the time specified by the **Ratio Delay** setting elapses. When exiting the Ratio Output mode, the PID loop performs a bump-less transfer back into automatic mode.

When set to **Setpoint**, the Ratio function will sample the current Setpoint value, multiply that by the **Ratio Multiplier** value and hold that multiplied value until the contact is released and the time specified by the **Ratio Delay** setting elapses. During the time the Ratio Setpoint mode is active, the PID control loop will continue to adjust the output to maintain the ratioed setpoint.

The **Line Speed** setting serves a different purpose. Instead of sampling and holding the current Line Speed, the Ratio function will continually update the output with the real-time Line Speed value multiplied by the **Ratio Multiplier** value until the contact is released and the time specified by the **Ratio Delay** setting elapses. With **Ratio Multiplier** set to 1.0, for example, the output while Ratio Line Speed is active will be the current line speed. A valid Line speed input is required when using the Ratio Line Speed setting (see Section 6.2, Line/Roll Speed Input Calibration).

To set the target, navigate to the *Setup Menu > Ratio Setup* menu and set the **Ratio Target** setting to the desired target.

Also, within the Ratio Setup menu, set the **Ratio Multiplier** setting to the desired ratio multiplier value.

Finally, set the **Ratio Delay** setting to the desired length of time to hold the controller in Ratio mode after the external contact is released. This feature can be used to hold the controller in Ratio mode for a specific period of time after a momentary contact closure.

In tension display mode, Hold and Ratio alarm indicators will appear on the screen whenever the Hold or Ratio modes are active. The Ratio function has a greater priority than the Hold function. Meaning if the Ratio function is activated after the Hold function is already active, the Ratio function will ratio the output currently held by the Hold function, overriding the Hold function. The Hold and Ratio functions are only active when the controller is in Auto mode (not in Manual mode).

## 7.7 TENSION LIMIT SWITCH SETUP

The TLS (Tension Limit Switch) feature is used to provide an alarm when web tension exceeds or drops below user specified levels. When a TLS condition occurs, the controller issues a visual alarm to the tension display and can also activate a Relay contact. The TLS condition can also be used to disable controller output (turn Tension Off).

There are two TLS modes, **Momentary** and **Latched**, which can be set individually for the TLS High and TLS Low alarms.

### 1. **Momentary**

Momentary mode should be selected if it is desired to automatically make the TLS alarm disappear after tension has returned to the specified range.

### 2. **Latched**

Latched mode should be selected if manual intervention is desired to make the TLS alarm disappear after tension has returned to the desired range. If Tension Off by TLS is activated the operator may not be able to turn Tension On while TLS is active. In this situation, the operator must press and hold the RESET TLS button, then turn Tension On and wait until tension comes back into range, at which point the alarm will be cleared and the operator may release the RESET TLS button.

### Low Tension Limit Switch

To enable TLS Low, navigate to the *Setup Menu > Tension Limit Switch Setup* menu and set the **TLS Low Mode** setting to the desired mode of operation, **Momentary** or **Latched**.

Also, within the *Tension Limit Switch Setup* menu, set the **TLS Low Setpoint** setting to the desired trip point. Set the **TLS Delay** setting to the desired length of time tension must be below the **TLS Low Setpoint** for the TLS Low mode to activate. This is used to prevent nuisance tripping from tension dropping below the trip point for a brief period of time. Note that the TLS Delay setting applies to both the TLS Low and TLS High modes.

If it is desired to disable the control output during a TLS Low event, set the **Tension Off by TLS Low** setting to **Yes**.

To activate or deactivate the Relay card during a TLS condition, refer to Section 7.10, Relay Option Setup.

### High Tension Limit Switch

To enable TLS High, navigate to the *Setup Menu > Tension Limit Switch Setup* menu and set the **TLS High Mode** setting to the desired mode of operation, **Momentary** or **Latched**.

Also, within the *Tension Limit Switch Setup* menu, set the **TLS High Setpoint** setting to the desired trip setpoint.

Set the **TLS Delay** setting to the desired length of time tension must be above the **TLS High Setpoint** for the TLS High mode to activate. This is used to prevent nuisance tripping from tension rising above the trip point for a brief period of time. Note that the TLS Delay setting applies to both the TLS High and TLS Low modes.

If it is desired to disable the control output during a TLS High event, set the **Tension Off by TLS High** setting to **Yes**.

To activate or deactivate the Relay card during a TLS condition, refer to Section 7.10, Relay Option Setup.

## 7.8 DIAMETER ALARM SETUP

The diameter alarm feature is used to provide an alarm when roll diameter exceeds or drops below user specified levels. When a diameter alarm condition occurs, the controller issues a flashing red message to "RESET DA" on the tension display and activates an external relay card (P/N 723-2095).

The diameter alarm is triggered when the diameter falls below the **Minimum Diameter Trip Point** or rises above the **Maximum Diameter Trip Point** for the amount of time specified by the **Diameter Alarm Delay** setting. Once the diameter alarm is triggered, it will persist until reset by manually pressing the flashing message on the screen, even if the roll diameter returns to the acceptable range, such as may occur with a roll that is badly out-of-round. If the diameter alarm is reset while the roll diameter is still outside the acceptable range, it will not trigger again until after the roll diameter has returned to the acceptable range, and again crosses the trip point.

To enable the diameter alarm, navigate to the *Setup Menu > Diameter Setup* menu and set the **Diameter Alarm** setting to **On**.

Also, within the *Diameter Setup* menu, set the **Minimum Diameter Trip Point** or **Maximum Diameter Trip Point** setting to the desired trip point, noting that only the alarm for minimum Core Diameter may be set in an unwind zone, for maximum Full Roll Diameter in a rewind zone and that neither may be set in an intermediate zone.

Set the **Diameter Alarm Delay** setting to the desired length of time roll diameter must be below or above the trip point for the diameter alarm to activate. This is used to prevent nuisance tripping from diameter crossing the trip point for a brief period of time. Refer to figure 4-10 for the diameter alarm connection diagram.

## 7.9 INPUTS SETUP

The controller can be configured for remote control by interfacing external potentiometers, dry contacts, PLCs, etc., to the Signals terminal block (TB3). This allows for remote Tension On / Tension Off and Auto / Manual capability, as well as remote Auto setpoint and remote Manual setpoint input.

The Auto and Manual setpoints can be set by one of 3 methods:

- Directly from the front panel.
- Remotely by input from an external potentiometer.
- Remotely by a 0-10 VDC input from a PLC or other logic device.

Note that only one method of input can be specified at a time for each setpoint. That method may be different for each setpoint, however. For example, **Auto Setpoint** can be set to **Front Panel** and **Manual Setpoint** can be set to **Potentiometer**, but **Auto Setpoint** cannot be adjustable from both the **Front Panel** and a **Potentiometer** simultaneously.

### 1. Front Panel

The default settings for both **Auto Setpoint** and **Manual Setpoint** is **Front Panel**. This allows adjustment of the setpoints on the display directly.

### 2. Potentiometer

The **Potentiometer** input option allows an external 10k Ohm potentiometer to be used for setpoint adjustment. The potentiometer is connected to the control board's Signal terminal block (TB3).

To connect an Auto Setpoint potentiometer, the wiper should be connected to TB3 terminal 15 (A SET), and the other two power leads should be connected across terminal 18 (+10/+15V) and terminal 17 (GROUND) (see Section 4.11, Standard Electrical Connections).

To connect a Manual Setpoint potentiometer, the wiper should be connected to TB3 terminal 16 (M SET), and the other two power leads should be connected across terminal 18 (+10/+15V) and terminal 17 (GROUND) (see Section 4.11, Standard Electrical Connections).

The voltage at terminal 18 (+10/+15V) is dictated by jumper JP6, towards the top of the control board (see Section 2.9 Customer +10/15V Output Selection). For setpoint potentiometers, it is recommended to set JP6 to 10V (pins 2 and 3). The 10V potentiometer voltage rail, like all power voltage rails, can drift with time and temperature. With the setpoint setting set to **Potentiometer**, the controller monitors the 10V rail and determines the setpoint by calculating the potentiometer's wiper voltage as a percentage of the 10V rail voltage. This compensates for any voltage supply drift. The potentiometer itself, however, being a mechanical device, may experience its own drift due to temperature and vibration. This makes the use of a potentiometer less precise than that of direct front panel setpoint adjustment.

**Note:** While it is possible to use a common potentiometer to control both the Auto and Manual setpoints, it is strongly recommended to use two separate potentiometers in such a situation, one dedicated for each setpoint.

### 3. 0-10V Input

The **0-10V** Input option allows an external 0-10V signal to control the setpoint. This works very similar to the potentiometer input as described above, with the exception that the internal 10V rail drift compensation is not performed. It is assumed that the provided 0-10V signal is a precision single ended signal. Any drift in the signal will cause corresponding setpoint drift.

To connect a remote 0-10V Auto Setpoint signal, the 0-10V signal should be connected to TB3 terminal 15 (A SET) and the corresponding ground lead should be connected to terminal 11 (GROUND) (see Section 4.11, Standard Electrical Connections).

To connect a remote 0-10V Manual Setpoint signal, the 0-10V signal should be connected to TB3 terminal 16 (M SET) and the corresponding ground lead should be connected to terminal 12 (GROUND) (see Section 4.11, Standard Electrical Connections).

#### **Auto Setpoint**

To specify the Auto Setpoint source, navigate to the *Setup Menu > Inputs Setup* menu and set **Auto Setpoint** to the desired setting. Controlling the Auto Setpoint from either of the external options (potentiometer or 0-10V Input) will override the default control, rendering the on-screen +/- buttons ineffective.

#### **Manual Setpoint**

To specify the Manual Setpoint source, navigate to the *Setup Menu > Inputs Setup* menu and set **Manual Setpoint** to the desired setting. Controlling the Manual Setpoint from either of the external options (potentiometer or 0-10V Input) will override the default control, rendering the on-screen +/- buttons ineffective.

#### **External Tension On/Off, Auto/Manual**

In addition to the front panel Tension On/Off and Auto/Manual function keys, the Tension On/Off and Auto/Manual state can be controlled by remote switches or relays by shorting the relevant input terminal to ground. There are 4 separate input terminals to control these states:

- Tension On, TB3 Terminal 4, TEN ON
- Tension Off, TB3 Terminal 3, TEN OFF
- Auto Mode, TB3 Terminal 7, AUTO
- Manual Mode, TB3 Terminal 8, MANUAL

Each terminal is activated on a falling edge (to ground). The control board inputs have built in weak pull-ups, so there is no need to connect any voltage to these terminals. A switch or relay to ground is all that is required. TB3 terminals 5 and 6 provide convenient ground connections in close location to the control inputs (see Section 4.11, Standard Electrical Connections).

In some cases, it may be desirable to use one external switch or relay to toggle the Tension or Control state (instead of using two for each). In this case the **External Tension Toggle** (for Tension On/Off) or **External Auto Manual Toggle** (for Auto/Manual mode) setting, located in the *Setup Menu > Inputs Setup* menu, can be set to On.

When **External Tension Toggle** is enabled, a single switch or relay between TB3 Terminal 4 (TEN ON) and ground is all that is required. Each falling edge (to ground) on this input terminal will cause the current Tension On/Off state to toggle.

Similarly, when **External Auto Manual Toggle** is enabled, a singled switch or relay between TB3 Terminal 7 (AUTO) and ground is all that is required. Each falling edge (to ground) on this input terminal will cause the current Auto/Manual state to toggle.

Unlike the external analog setpoint inputs, which cannot be used simultaneously with front panel setpoint input, the external Tension On/Off and Auto/Manual inputs can be used in conjunction with the on-screen On / Off and Auto / Man toggle buttons, even when using the External Toggle modes of input.

## 7.10 RELAY OPTION SETUP (INCLUDED IN TLS OPTION)

Use of the Relay functionality requires a Relay option card (P/N 723-2095). This card must be installed into the RELAY slot on the control board (plugging into P6) and mounted properly to the three supportive mounting studs (see Figure 4-12, Option Card Mounting Locations). See section 4.15, Relay Option Card Electrical Connections, for relay wiring information, including the recommended use of a snubber network.

The Relay function is determined by the **Relay Function** setting, located in the *Setup Menu*. Selectable options are **Tension On**, **TLS On** and **TLS OFF**.

**Tension On** energizes the relay whenever the controller Tension On/Off state is On.

**TLS On** energizes the relay whenever the TLS High or TLS Low is active.

**TLS Off** energizes the relay when tension is in a valid range (TLS High and TLS Low are inactive).

## 7.11 COMMUNICATION OPTIONS SETUP

The controller is available with RS485 and RS232 Communication Options. Configuration and use of the Communication Option cards are explained in the SW6 Communications Insert (DOC 801-2542). The Communications Insert will be shipped with the card, or can be downloaded from the DFE website, [www.DFE.com](http://www.DFE.com). If a Communication Option card is not installed, all Communication related settings should be left in their default, Off, state.

## 7.12 TENSION ON RELAY OPTION

Used to enable a drive or other input when tension is on. See Section 7.10 for setup. Not compatible with TLS when TLS is using a relay output.

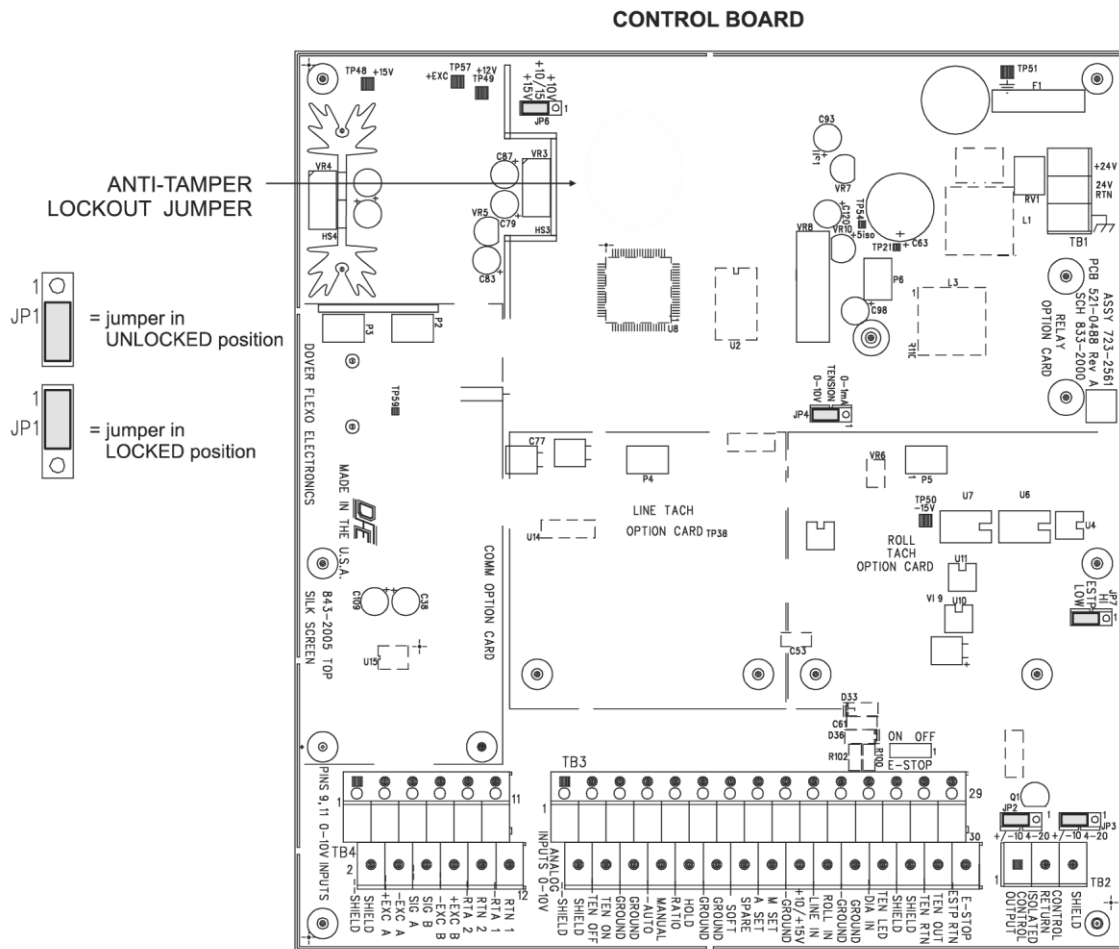
## 7.13 POWER ON SETTINGS

The power on Auto / Manual and Tension On / Off states can be configured with the **Power On Control Mode** and **Power On Tension Mode** settings. Both of these settings are located in the *Setup Menu > Tension Ctrl Setup* menu.

## 7.14 ANTI-TAMPER/SECURITY LOCKOUT

The Anti-Tamper jumper (JP1) (see Figure 7-1, Anti-Tamper Lockout Jumper) can be used to limit operator access to certain menu functions and settings. When the jumper is placed between pins 1 and 2, Anti-Tamper is enabled, and only settings within the Operator Menu are adjustable from the front panel. All locked out menu items become shaded gray. Operators may still navigate the menu system, but attempting to access a gray (locked out) menu item will cause a message to be displayed informing the operator that the menu item is currently locked out.

When the Anti-Tamper jumper is positioned between pins 2 and 3 of JP1, full access to all menu items is restored.



**Figure 7-1 – ANTI-TAMPER LOCKOUT JUMPER**



# 8 TUNING ADJUSTMENTS

---

## 8.1 PID CONTROL TUNING

There are three tuning adjustments that set the controller's response to tension error (error referring to the difference between the set point and the actual tension measurement). The Proportional, Integral and Derivative adjustments are also more intuitively referred to as Gain, Stability and Response.

1. The Proportional, or Gain, term causes an instantaneous response proportional to the tension error, setting the sensitivity of the controller. A low setting will produce a smaller output change while a high setting will produce a larger output change for a given tension error. Increasing the Gain term increases the response of the controller, but can also lead to instability.
2. The Integral, or Stability, term remembers the error history to allow response to both the size and length of tension error. Long duration errors, for example, will lead to greater Integral response than short duration errors. This term helps the controller maintain a stable output over time. Increasing the Stability term can decrease sensitivity to fast oscillations, but setting too high may cause the controller to ignore some tension variations and decreases the reaction time of the controller. A large Stability term can also lead to setpoint overshoot when responding to large errors.
3. The Derivative, or Response, term dictates the controller's response to the rate of tension change. This works against the Gain and Stability terms to limit or prevent overshoot by decreasing the response rate for fast tension changes, effectively providing a damping effect. The Response term can be sensitive to tension noise (high frequency tension variations) and can cause instability when set too high or when significant noise is present. One way to help limit noise sensitivity is to increase the **Tension Filter Time** setting, but doing this also increases delay which can add instability to the system. Many tension systems require little or no Response and so this term should initially be kept low.

It can help to think of the three tuning adjustments in terms of time, with Gain causing an instantaneous response to error, Stability “looking back” (or remembering) the previous error, and Response “looking ahead” to anticipate the future error based on the rate of tension change. As in most control systems, tuning involves striking a balance between response and stability. Systems tuned for more aggressive response to error may find themselves more easily overshooting the setpoint and possibly falling into oscillation, while systems tuned over conservatively may be less responsive to tension error. Some experimentation and trial and error may be necessary to find the optimal tuning values for each system and process. The SteadyWeb 6™ **PID Tune View** display can greatly facilitate the tuning process by allowing the operator to visualize the response of the system and the effect PID changes have on that response (see Section 5.4, PID Tune View). Some time spent using the **PID Tune View** can lead to an intuitive feel for the impact of each of the tuning parameters.

## 8.2 TUNING PROCEDURE

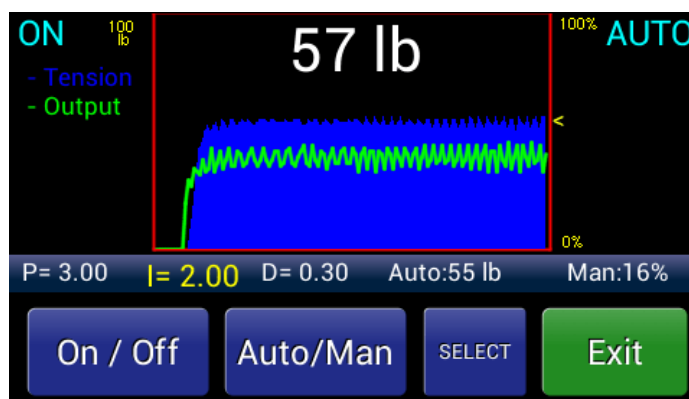
The following steps can be used as a guide to tuning the PID values. It may take some trial and error to achieve desirable tuning. Depending on the application, some of the more advanced tuning adjustments may be necessary. These are discussed in the following sections.

1. Start off with the default P, I and D settings (1.5, 2.5 seconds and 0.5 seconds respectively). Most systems will run steadily with these initial settings.
2. Run the machine at normal operating speed with the controller in Auto mode and the tension setpoint at a typical value.

3. From within the PID Tune View screen, vary the stability (I) setting up or down as necessary to stabilize the tension. Wait after each adjustment for tension to stabilize. If the control output appears to be having large and fast fluctuations, increase the I term.
4. Accelerate the machine while watching the tension and output in the PID Tune View screen. If tension oscillates, increase the I term or decrease the P term. If tension lags excessively, reduce the I term or increase the P term.
5. From within the PID Tune View screen, make setpoint changes and watch the tension and output. If the tension overshoots the setpoint, increase the D term. Be careful not to increase the D term too rapidly and ensure increasing the D term doesn't increase output fluctuations. The D term should typically be low. If setpoint changes cause large output fluctuations, decrease the D term.
6. Continue to adjust the P, I and D terms as necessary to ensure accurate and stable control during both machine speed and tension setpoint changes. See the following section (Section 8.3, Tuning Examples) for recommended action to address specific tuning issues.

### 8.3 TUNING EXAMPLES

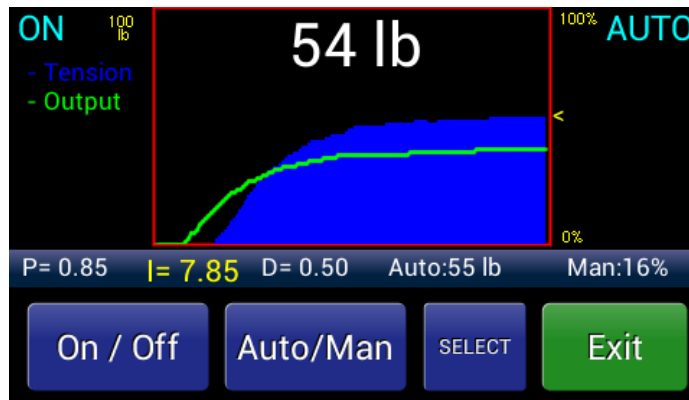
The following figures provide some examples of the tuning parameters' effect on overall tension control. In these figures, the controller's **Ratio Target** setting is set to **Setpoint** and the **Ratio Multiplier** setting is set to 1.5. Pulling the RATIO terminal to ground in this configuration causes the tension setpoint to instantly increase by 50%. Once the RATIO terminal is released from ground, the setpoint returns to its original value after delaying for the time specified by the **Ratio Delay** setting. This allows testing the controller's "step response." The PID Tune View's PAUSE/RESUME feature was utilized to capture the controller's response to various PID changes on a tension simulator, which was used to demonstrate the impact of PID adjustments.



**Figure 8-1 – TUNING SCREEN SHOWING OVERSHOOT**

In Fig. 8-1, the controller responds too aggressively to setpoint changes. This causes the tension to overshoot the setpoint value.

Overshooting can be addressed by increasing the I term and/or decreasing the P term. In some cases, increasing the D term can also help limit or prevent overshoot, especially with high inertia, slow response systems. The D term should not be increased too much, however, as it can lead to instability issues. The D term should always be smaller than the I term.

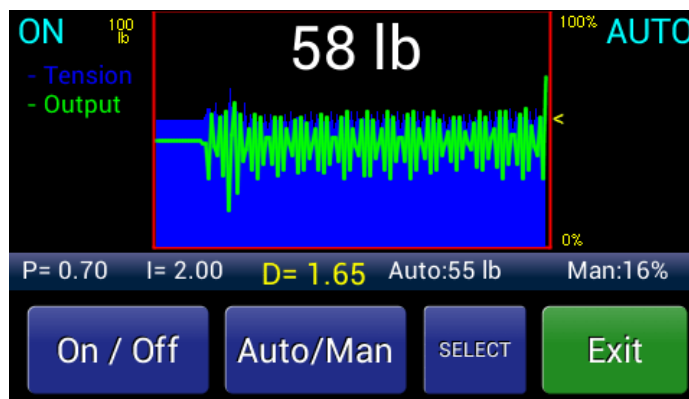


**Figure 8-2 - TUNING SCREENS SHOWING ADJUSTMENT RESPONSES**

In Fig. 8-2, the Improved Response screen shows the P term was reduced and both the I and D terms were increased. This reduced the overshoot seen in Fig. 8-1. The goal of attaining a well-tuned system is to adjust the tuning parameters to achieve "critical damping." A critically damped system will respond to changes as quickly as possible without any oscillation.

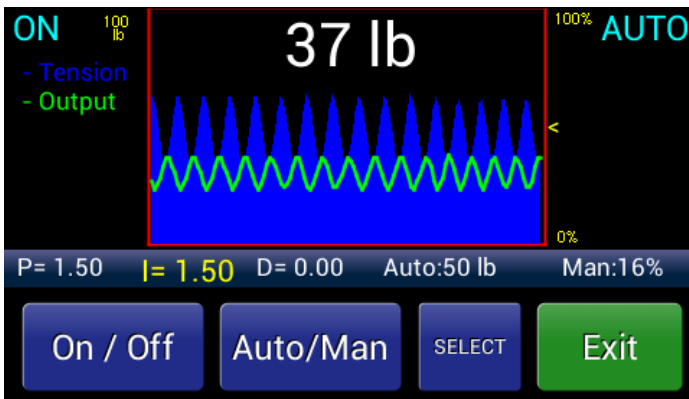
Slow Response screen shows the P term was reduced further and the I and D term were increased further, causing the controller to respond sluggishly to setpoint changes.

Sluggish response can be addressed by decreasing the I term and/or increasing the P term. In certain situations, it can also be improved by decreasing the D term.



**Figure 8-3 – DERIVATIVE NOISE**

In Fig. 8-3, Derivative Noise, the D term is increased until it causes instability. Here, a small wobble in the tension reading is amplified by the D term and eventually causes wild oscillations. This can be abusive to drive motors or other devices connected to the controller's output and should be avoided. In certain cases, especially when using heavy tension reading damping in the Display mode screen, the tension may appear to be or may actually be controlled reasonably well with a highly fluctuating output. This is why it is useful to use the PID Tune View screen to monitor both the tension and the output while tuning. Large and fast output changes can be addressed by decreasing the D and P terms and increasing the I term. Increasing the **Tension Filter Time** can also aid in reducing Derivative susceptibility to tension noise.



**WOBBLE COUPLED ONTO OUTPUT**



**WOBBLE FILTERED FROM OUTPUT**

**Figure 8-4 – SCREENS SHOWING WOBBLE**

In Fig. 8-4, Wobble Coupled onto Output, there is some wobble present on the tension signal. The wobble frequency is too high to be addressed through the tension control system. To remove this tension variation would require addressing the source of the wobble. The control output, however, also has a small amount of wobble coupled into it as it tries to correct the tension wobble. In certain situations, this can actually lead to worse tension control. Increasing the I term helps to limit the output wobble, as seen in Fig. 8-4, Wobble Filtered from Output.

## 8.4 ADVANCED TUNING ADJUSTMENTS

One of the difficulties involved with tension control is that a tension system's process variables can vary widely from one process to another, or even over the same process. Roll diameter is one such variable. A large roll has greater inertia and may require more aggressive control than a small roll. Diameter Compensation accounts for this by allowing the use of two sets of PID values, one for core diameter and a second for full roll diameter. The controller monitors roll diameter and adjusts the PID values from the core values to the full roll values as diameter increases or from full roll values to core values as diameter decreases.

Acceleration is another variable that can impact tension control. A system accelerating web to process speed upon start up, for example, may require more aggressive PID values than when operating at steady-state process line speed. As it is difficult to manually tune a system during an acceleration period, Acceleration Compensation uses multipliers to ratio the PID values off of the standard values during periods of acceleration.

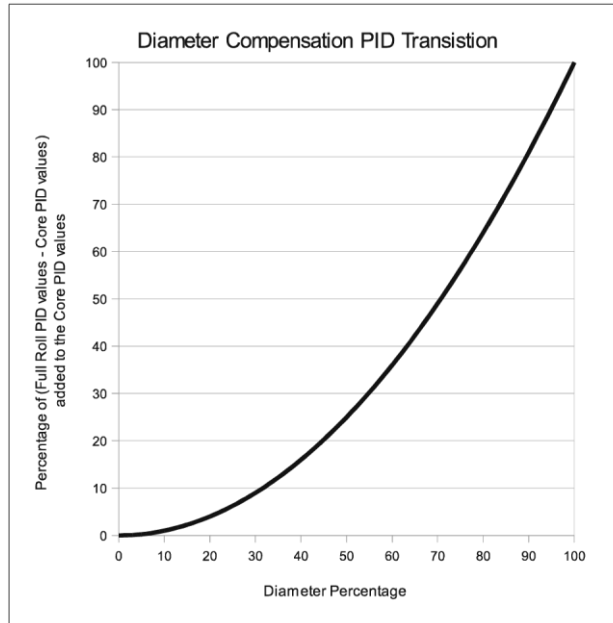
More information about using Diameter and Acceleration compensation is provided in the following section.

## 8.5 DIAMETER COMPENSATION

Diameter Compensation is disabled in the intermediate zone. To use Diameter compensation, both the standard (or core) PID values and the full roll PID values must be programmed and the **Diameter Compensation Enable** setting must be enabled. These settings can be found in the *Calibration > Diameter Compensation* menu. The full roll settings can be set individually through the menu system or by using the Full Roll PID Tune View screen, which allows the user to see real time tension, output and set point information while tuning the PID values. When using the Full Roll PID Tune View screen, the

system should be running as close to full roll diameter as possible and the **Diameter Compensation Enable** setting must be enabled.

The area of a circle, and therefore the mass of a roll, exhibits quadratic growth as a function of its radius. The transition from Core PID values to Full Roll PID values accounts for this by transitioning the PID terms as described in the following graph (Figure 8-5).



**Figure 8-5 – DIAMETER COMPENSATION PID TRANSITION**

## 8.6 ACCELERATION COMPENSATION

To use the acceleration compensation feature, the acceleration multipliers for each PID setting, as well as the **Acceleration Limit** and line **Acceleration Percentage** settings should be programmed. The **Acceleration Compensation Enable** setting must then be enabled. These settings can be found in the *Calibration Menu > Acceleration Compensation* menu. Unlike Diameter compensation, which gradually transitions the PID terms as the roll diameter changes, Acceleration Compensation is either active or inactive. When active, the standard PID terms are multiplied by the by the **Accel P Multiplier**, **Accel I Multiplier** and **Accel D Multiplier** respectively. Activation of Acceleration Compensation is dependent on both the **Acceleration Limit** and **Acceleration Percentage** settings. The Line speed must be below the value specified by the **Acceleration Limit** setting and Line acceleration must be greater than the value specified by the **Acceleration Percentage** setting. **Acceleration Percentage** is programmed as a level of percent change per second, which should be set to a level at least equal to the acceleration which occurs when the machine is starting (or when Acceleration Compensation must be activated). Some trial and error may be necessary to find PID multiplier and line speed/acceleration threshold values that work well for a given system.

## 9 OPERATING INSTRUCTIONS

---

### 9.1 BASIC OPERATION

When the controller has been properly set up and the control loop has been tuned, it should maintain constant tension while the machine is running and while speed, roll diameter, or other conditions change. However, during startup of a new roll you may want to change modes, setpoint or other settings. Usually, the only thing the operator will need to do is turn tension On or Off, toggle between Auto and Manual modes, and change the Auto tension setpoint or Manual output setting.

With tension off, to turn tension on and enable output, press the tension On / Off button. If the controller is in Auto mode, the output will ramp up or down to tension the web to the Auto Tension Setpoint. If the controller is in Manual mode, the output will change to the manual output setting. Either the auto or manual mode will be indicated as active by the Auto / Man status indicator in the upper right-hand corner of the display. The Auto and Manual modes can be toggled back and forth by pressing the Auto / Man button.

While in either auto or manual mode, the "+" & "-" buttons for adjusting the auto tension setpoint or the manual output setting can be brought up by touching the tension display screen.

### 9.2 DISPLAY ADJUSTMENTS

Display Adjustments serve visual purposes only, do not affect the control loop, and are operator adjustable. Refer to Section 2.2, Display Adjustments, for a detailed description.

### 9.3 SAVING, RECALLING AND DELETING SETUPS

As many as 30 setups, each composed of different combinations of selections and settings under the Operator Menu, may be named, saved, recalled and deleted from the SW6 by the operator. See Section 2.3, Saving, Recalling and Deleting Setups, for additional information.

### 9.4 SETTING AUTO AND MANUAL SETPOINTS

The Auto and Manual Setpoints are set and adjusted using "+" and "-" buttons that appear on the tension display after the operator presses or taps the display area of the screen. Refer to Section 2.4, Auto Tension Setpoint and Manual Output Setting, for additional detail.

### 9.5 USING TAPER

In some cases where poor roll quality might result from winding the entire roll at constant tension, certain types of roll quality problems can be avoided by reducing the tension as the diameter of the roll increases from the core. This reduction is known as **Taper**, and may be enabled, adjusted and disabled by the operator per Section 2.5, Taper Tension.

### 9.6 TLS ALARMS, DIAMETER ALARM AND RESETTING THEM

Using TLS Alarms and the Diameter Alarm and resetting both are Operator functions, and are described in Sections 2.6, TLS, Alarms and Resetting them, and 2.7, Resetting Diameter Alarm.

### 9.7 ZEROING TENSION

The tension transducers may be zeroed at any time while no web is on the tension roll. Tension zero may be performed without calibration using the **Set Zero Tension** function, located in the *Calibration Menu*.

**Note:** Do NOT use this function with web on the transducers. The current tension value will become the new zero, ruining the calibration.

## 10 CARE AND MAINTENANCE

---

It is not necessary to perform any type of maintenance on the controller. However, you may find it worthwhile to observe whether there is buildup of dust, debris or moisture on or near the unit after a period of time. If so, you may consider moving the unit or putting the unit in an enclosure more suited to your particular environment.

The exterior of the unit may be wiped clean with a mild detergent on a damp cloth. Disconnect power prior to cleaning. Do not spray or pressure wash the unit. Ensure the unit is dry prior to reconnecting power. Validation of tension reading is recommended during your periodic maintenance cycle.

# 11 TROUBLESHOOTING GUIDE

## 11.1 GENERAL TROUBLESHOOTING TIPS

Most problems are caused by incorrect installation or misapplication of the equipment, so it is important to read through the manual and follow the proper installation, calibration and configuration procedure. If you would like assistance evaluating your installation, please call Technical Service at:

Phone: (603) 332-6150  
Fax: (603) 332-3758  
Email: [techsupport@dfc.com](mailto:techsupport@dfc.com)

We offer experienced technicians whose responsibility it is to make sure you are satisfied with your DFE equipment. They will be pleased to help you.

The most common source of improper operation of tension equipment is incorrect installation of the tension transducers or using transducers of the wrong load rating. Refer to your transducer instruction manual and check the sizing and installation procedures to verify the installation.

**Note:** Avoiding preloading the transducers is very important.

If changes cannot be made to menu selections, check to make sure that the Anti-Tamper Lockout Jumper is not in the locked position. Refer to Section 7.14 for more detail.

For controllers with a pneumatic output, check the following factors:

1. The output pressure should not fall below 5 psi at core diameter. If it does, the controller may be unstable. This is caused by the compressibility of air, which creates a time delay when the controller calls for a change of output pressure. At low pressures the delay becomes long.
2. The air connection between the controller and the brake or clutch should be 1/4 inch O.D. tubing, no longer than 25 feet long. Larger or longer tubing creates excessive volume which causes a time delay when output pressure changes. This can cause instability. If greater distance is unavoidable, the pneumatic enclosure should be moved closer to the brake or clutch. Use of a volume booster is an alternative. Call Technical Service at (603) 332-6150 for details.

## 11.2 ERROR MESSAGES

DISPLAYED ERROR	CAUSE	RESOLUTION
ERROR: EXCITATION Short or low impedance detected. Check transducer wiring.	A short circuit or low impedance condition is detected on one or both of the excitation lines. This could be caused by a miswire, a damaged (failed short) transducer strain gage or an incorrect excitation voltage setting.	<ul style="list-style-type: none"><li>• Ensure the proper excitation voltage setting. The voltage should not be set to <b>10V Set</b> when using STD transducers.</li><li>• Check transducer wiring. See Appendix D: Transducer Electrical Connections and Section 4.11, Standard Electrical Connections.</li><li>• Verify correct transducer resistance. ~200 Ohm per half of the transducer bridge for STD transducers, ~400 Ohm per half of the transducer bridge for XR transducers.</li></ul>



<p><b>ERROR: EXCITATION</b> Open Circuit. Verify transducers are connected. Check transducer wiring.</p>	<p>An open circuit condition is detected on one or both of the excitation lines with the <b>Excitation Voltage</b> setting set to <b>Auto</b>. This could be caused by having no transducers connected to the unit or by a miswire in the transducer connection. Other possibilities are the use of non traditional high impedance transducers (not DFE STD or XR), a damaged (failed open) transducer strain gage, or a broken wire in the cable to the transducer(s).</p>	<ul style="list-style-type: none"> <li>• Ensure transducers are connected to the controller.</li> <li>• Check transducer wiring. See Appendix D: Transducer Electrical Connections and Section 4.11, Standard Electrical Connections.</li> <li>• If using nontraditional high impedance transducers (not DFE STD or XR), set the <b>Excitation Voltage</b> setting to the voltage required for the transducers (<b>5V Set</b> or <b>10V Set</b>). Do not use the Auto setting.</li> <li>• Verify correct transducer resistance. ~200 Ohm per half of the transducer bridge for STD transducers, ~400 Ohm per half of the transducer bridge for XR transducers.</li> </ul>
<p><b>ERROR: EXCITATION</b> Unknown transducer type. Verify STD or XR transducer Check transducer wiring.</p>	<p>A STD transducer is detected on one half of the bridge and an XR transducer is detected on the other. This could be caused by mismatched transducers, miswiring, or a damaged transducer strain gage.</p>	<ul style="list-style-type: none"> <li>• Verify that both transducers are the same (both STD or both XR).</li> <li>• Check transducer wiring. See Appendix D: Transducer Electrical Connections and Section 4.11, Standard Electrical Connections.</li> <li>• If using nontraditional high impedance transducers (not DFE STD or XR), set the <b>Excitation Voltage</b> setting to the voltage required for the transducers (<b>5V Set</b> or <b>10V Set</b>). Do not use the Auto setting.</li> <li>• Verify correct transducer resistance. ~200 Ohm per half of the transducer bridge for STD transducers, ~400 Ohm per half of the transducer bridge for XR transducers.</li> </ul>
<p><b>ERROR: TRANSDUCER ZERO</b> Zero out of range. Check for overloading. Check transducer wiring.</p>	<p>The transducer analog to digital converter zero reading is at one of the input range extremes (0 or 65535). This could be caused by overloading, a transducer miswire, or a damaged transducer strain gage.</p>	<ul style="list-style-type: none"> <li>• Ensure the transducers are not overloaded.</li> <li>• Check transducer wiring. See Appendix D: Transducer Electrical Connections and Section 4.11, Standard Electrical Connections.</li> <li>• Verify correct transducer resistance. ~200 Ohm per half of the transducer bridge for STD transducers, ~400 Ohm per half of the transducer bridge for XR transducers.</li> </ul>
<p><b>ERROR: TRANSDUCER CAL</b> Minimum delta not met. Full range signal must exceed 15mV</p>	<p>The minimum calibration delta was not met during calibration, meaning the calibration reading is too close to the zero reading. The full range tension signal (from no tension to</p>	<ul style="list-style-type: none"> <li>• Ensure the minimum full range tension signal is at least 15mV. If necessary, the web angle may need to be increased, a different</li> </ul>

	<p>full scale tension) must exceed 15mV. This means when using a 10% (of full range) calibration weight, the signal difference between the Zero and Cal points must be at least 1.5mV or when using a 50% (of full range) calibration weight, the Zero and Cal signal difference must be at least 7.5mV.</p> <p>Too small of a signal could be caused by an improper transducer configuration, preloading, or a damaged transducer.</p>	<p>transducer orientation or a smaller load rating may be required.</p> <ul style="list-style-type: none"> <li>• Ensure there is no transducer pre-loading when using a pair of transducers on either side of the roll, such as model C transducers. There should be axial play to allow the shaft length to expand at higher temperatures and the transducers should be mounted with proper alignment. See the transducer manual for more information.</li> <li>• Check transducer wiring. See Appendix D: Transducer Electrical Connections and Section 4.11, Standard Electrical Connections. It is important that each half of the transducer bridge is powered by ex-citation voltage of opposite polarity so that the signal voltages move away from each other when tension is applied.</li> <li>• Verify correct transducer resistance. ~200 Ohm per half of the transducer bridge for STD transducers, ~400 Ohm per half of the transducer bridge for XR transducers.</li> <li>• Monitor the plus and minus signal lines, apply pressure to the roll and verify a changing signal.</li> </ul>
<p>ERROR: RIDER CAL Minimum delta not met. Full range signal must exceed 4V.</p>	<p>The minimum diameter input calibration delta was not met. There must be at least a 4V difference between the core diameter voltage and the full roll diameter voltage.</p>	<p>Adjust the arm angle on a rider roll, gain on an ultrasonic sensor, or other adjustments on the diameter measurement device to achieve at least a 4V difference between core and full roll sensing.</p>
<p>ERROR: ZERO OFFSET Maximum delta exceeded. Verify nothing is connected to analog inputs.</p>	<p>The maximum zero offset has been exceeded while attempting to perform a <b>Zero Signal Inputs</b> function.</p>	<p>Ensure that nothing is connected to the analog inputs while performing the <b>Zero Signal Inputs</b> function.</p>
<p>ERROR: CALIBRATION STATUS Control prohibited until tension calibration is completed.</p>	<p>Display and control of tension is prohibited until calibration has been completed.</p>	<p>Perform the tension calibration procedure (see Section 6.1, Tension Calibration) when interfacing directly with the transducers, or change the <b>Tension Source</b> setting to the correct RTA (Remote Tension Amplifier) input.</p>

## 11.3 DIAGNOSTIC SCREENS

The SteadyWeb 6™ Diagnostic menu provides displays and functions to monitor, troubleshoot and fine tune the controller's performance.

### 1. Software/Hardware Versions

The *Diagnostic Menu > Version Menu* display shows the controller's software and hardware versions. This can be useful in communication with DFE Technical support.

### 2. Monitoring Controller I/O

The *Diagnostic Menu > Read Digital Inputs* display provides a real time view of the Signal terminal block (TB3) digital inputs states. This includes the Tension Off, Tension On, Auto, Manual, Ratio, Sample & Hold, Soft Start and Spare inputs. The display reads **Off** for floating inputs and **On** for inputs that are pulled to ground. This display can be used to verify the proper functionality of switches or relays connected to the terminal block.

The *Diagnostic Menu < Read Analog Inputs > Transducer* This display provides a real time view of the tension millivolt reading, the current sense milli-amp reading for each half of the transducer bridge, and the transducer excitation voltage. For high resistances or open circuit conditions, no resistance value will be displayed and the words "Open Circuit" will be displayed. In the case of a low impedance or short circuit condition, no resistance will be displayed and the words "Short Circuit" will be displayed. This allows for transducer verification and/or troubleshooting.

The *Diagnostic Menu > Read Analog Inputs > Signal Inputs* display provides a real time view of the Signal terminal block (TB3) analog inputs' voltage readings. This includes the Diameter Input, Roll Input, Line Input, Remote Manual Setpoint Input, Remote Auto Setpoint Input, Remote Tension Input 1 (RTA1) and Remote Tension Input 2 (RTA2). In addition, there is a +10V/15V external rail (provided by TB3 terminal 18) monitor voltage provided. This allows for analog signal input verification and/or troubleshooting.

### 3. Manual Output Control

The *Diagnostic Menu > Write Analog Outputs > Isolated Control Out* screen has + & - buttons which allow the operator to manually adjust the isolated control output voltage (or current, as dictated by the control output jumpers). Tension must be Off and the controller must be in Manual mode in order to access this screen. Both the output voltage and current value are displayed. This allows for verification and/or troubleshooting of the isolated control output.

The *Diagnostic Menu > Write Analog Outputs > Tension Out* screen has + & - buttons which allow the operator to manually adjust the tension output voltage (or current, as dictated by the control output jumpers). Tension must be Off and the controller must be in Manual mode in order to access this screen. Both the output voltage and current value are displayed. This allows for verification and/or troubleshooting of the tension output.

### 4. Analog Zero Offsets

The *Diagnostic Menu > Adjust Analog Offset > Zero Signal Inputs* screen allows the operator to zero any offsets in the signal inputs (Diameter In, Roll In, Line In, Remote Manual Setpoint, Remote Auto Setpoint, Remote Tension Input 1 (RTA 1) and Remote Auto Input 2 (RTA 2)). This is done in the factory and should not have to be repeated unless the controller is reinitialized, clearing all memory. Zeroing the analog offsets will clear any small offset that is displayed in the *Diagnostic Menu > Read Analog Inputs > Signal Inputs* display when nothing is connected to the inputs. The **Zero Signal Inputs** function is designed to account for any small offsets caused by the analog circuitry in the controller, NOT to account for offsets in external components. For this reason, all signal input connections must be removed before running the **Zero Signal Inputs** function, even if the input is reading 0V, there could be a small offset that will add inaccuracy if not removed. Tension must be Off and the controller must be in Manual mode in order to access this screen.

The *Diagnostic Menu > Adjust Analog Offset > Control Out Zero Offset* screen allows the operator to adjust the control output zero offset. This is done in the factory and should not have to be repeated unless the controller is reinitialized, clearing all memory, or if the control output is changed from voltage to current mode (or vice versa). The offset is used to account for small hardware offsets in the analog circuitry and to ensure that a zero output is represented by 0.0V or 4.0mA. From within the screen, the offset can be adjusted and saved. When performing a zero-offset adjustment, a multimeter with at least 1mV (or 0.01mA in current mode) resolution should be used. Tension must be Off and the controller must be in Manual mode in order to access this screen.

The *Diagnostic Menu > Adjust Analog Offset > Tension Out Zero Offset* screen allows the operator to adjust the tension output zero offset. This is done in the factory and should not have to be repeated unless the controller is reinitialized, clearing all memory. The offset is used to account for small hardware offsets in the analog circuitry and to ensure that a zero output is represented by 0.0V. From within the screen, the offset can be adjusted and saved. When performing a zero-offset adjustment, a multimeter with at least 1 mV (or 0.01mA in current mode) resolution should be used. Tension must be Off and the controller must be in Manual mode in order to access this screen.

#### 5. **Advanced Menu**


*Diagnostic Menu>Advanced Menu*. The menu system will typically prevent the user from setting up invalid control configurations for traditional tension control applications. If the controller is set up for operation in an intermediate zone, for example, the Taper menu will be greyed out and the user will be unable to activate Taper. In certain unique circumstances, however, a user may wish to set up the controller for use in a non-conventional application. Enabling Advanced Menu mode will turn off all context-based control settings checking normally performed by software. The user may then configure the controller as they wish at their own risk.

#### 6. **Service Access**

*Diagnostic Menu>Service Access>Enter Service Code*. The Service Menu should be accessed only by, or with guidance from DFE Technical Support. Please contact us at (603) 332-6150.

#### 7. **System Statistics**

The *Diagnostic Menu > System Statistics > Reset Boot Counts* function will reset to 0 the following statistics: Comm CRC errors, Boot start count, Bootups completed and Front Panel Reset.

 **WARNING:** The *Diagnostic Menu > System Statistics > Reinitialize Controller* function can be used to completely clear the Controller's memory, returning it to a default state. **Caution:** This action should never be performed unless instructed to do so by DFE Technical Support. Reinitializing the controller will clear all saved Setups as well as the calibration values and the factory adjusted analog offset values.

# APPENDIX A: LOCATIONS OF JUMPERS AND ADJUSTMENTS

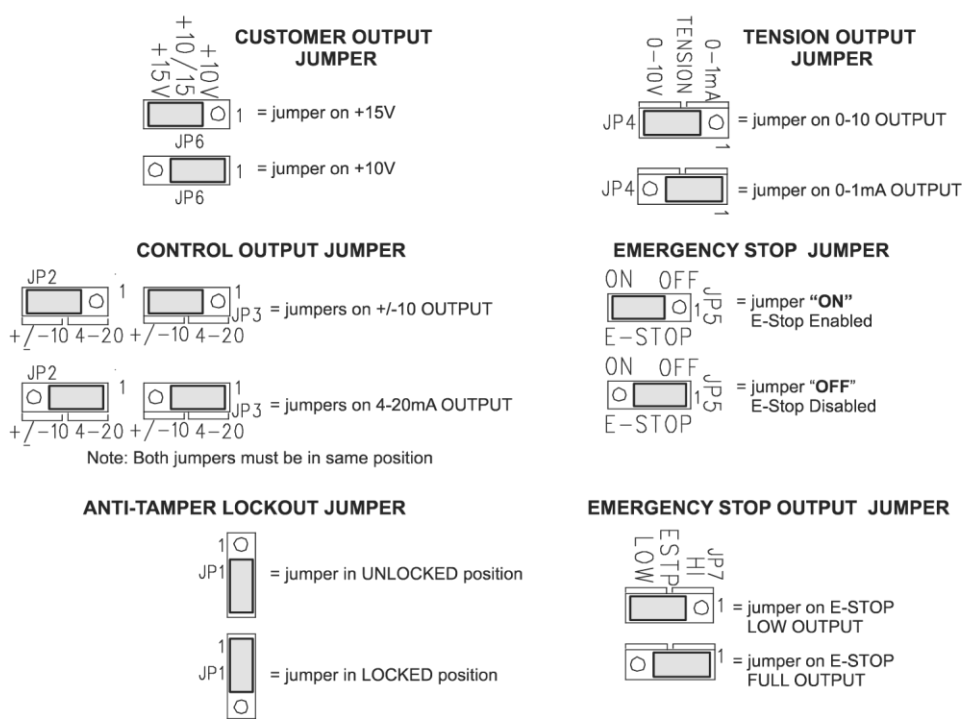
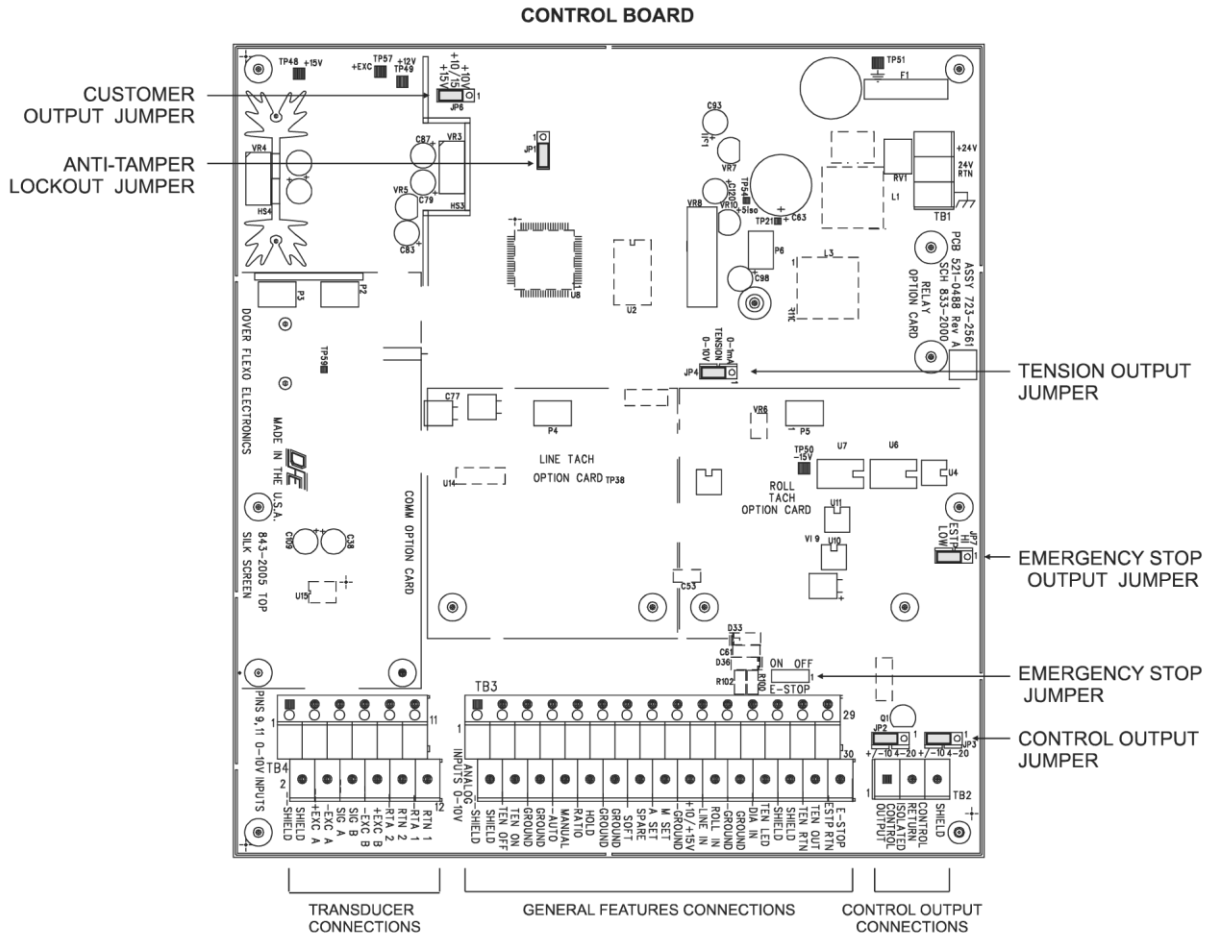


Figure A-1 - CONTROL BOARD SHOWING JUMPER LOCATIONS

# APPENDIX B: MENU HIERARCHY

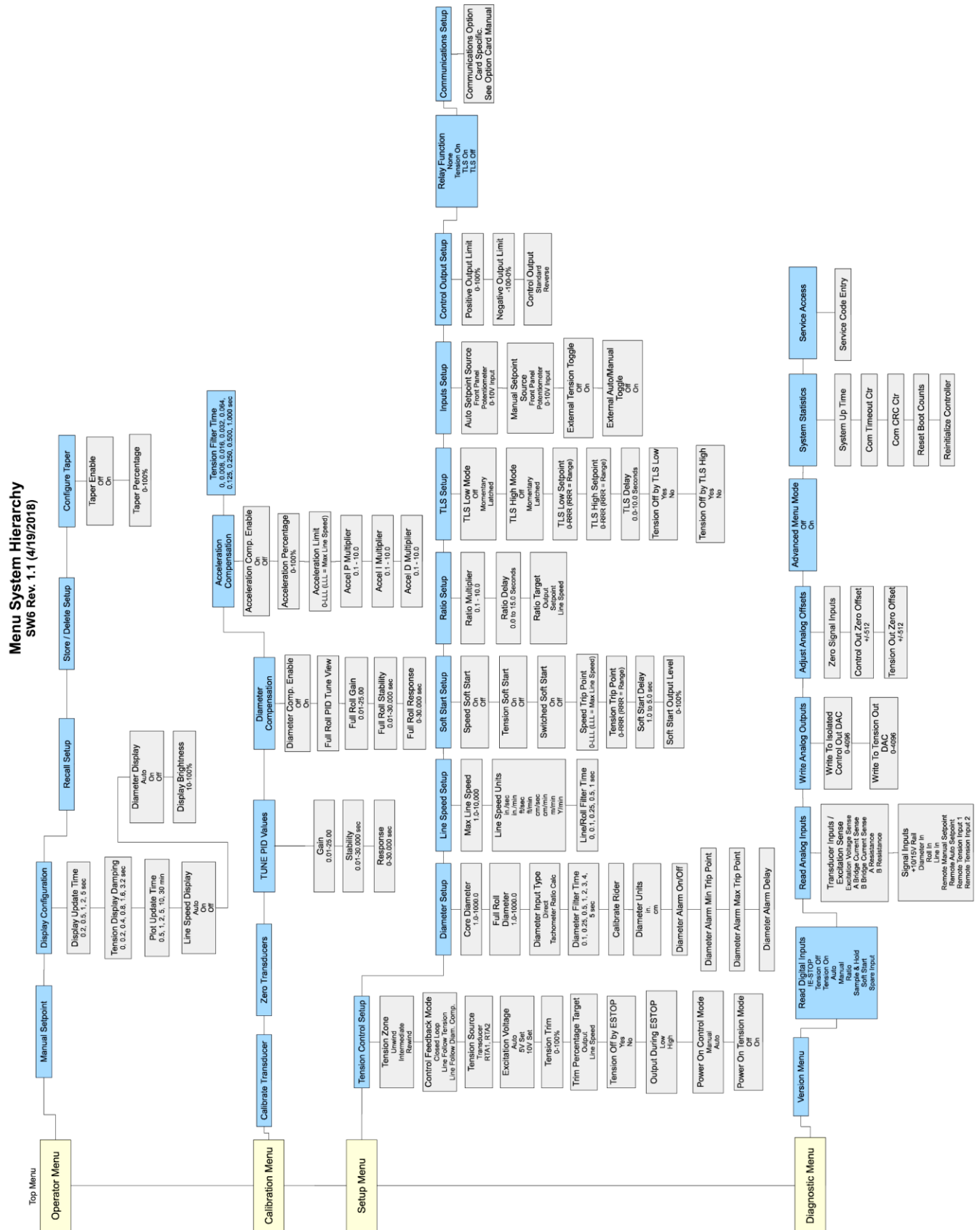


Figure B-1 - MENU HIERARCHY

# APPENDIX C: ELECTRICAL CONNECTIONS

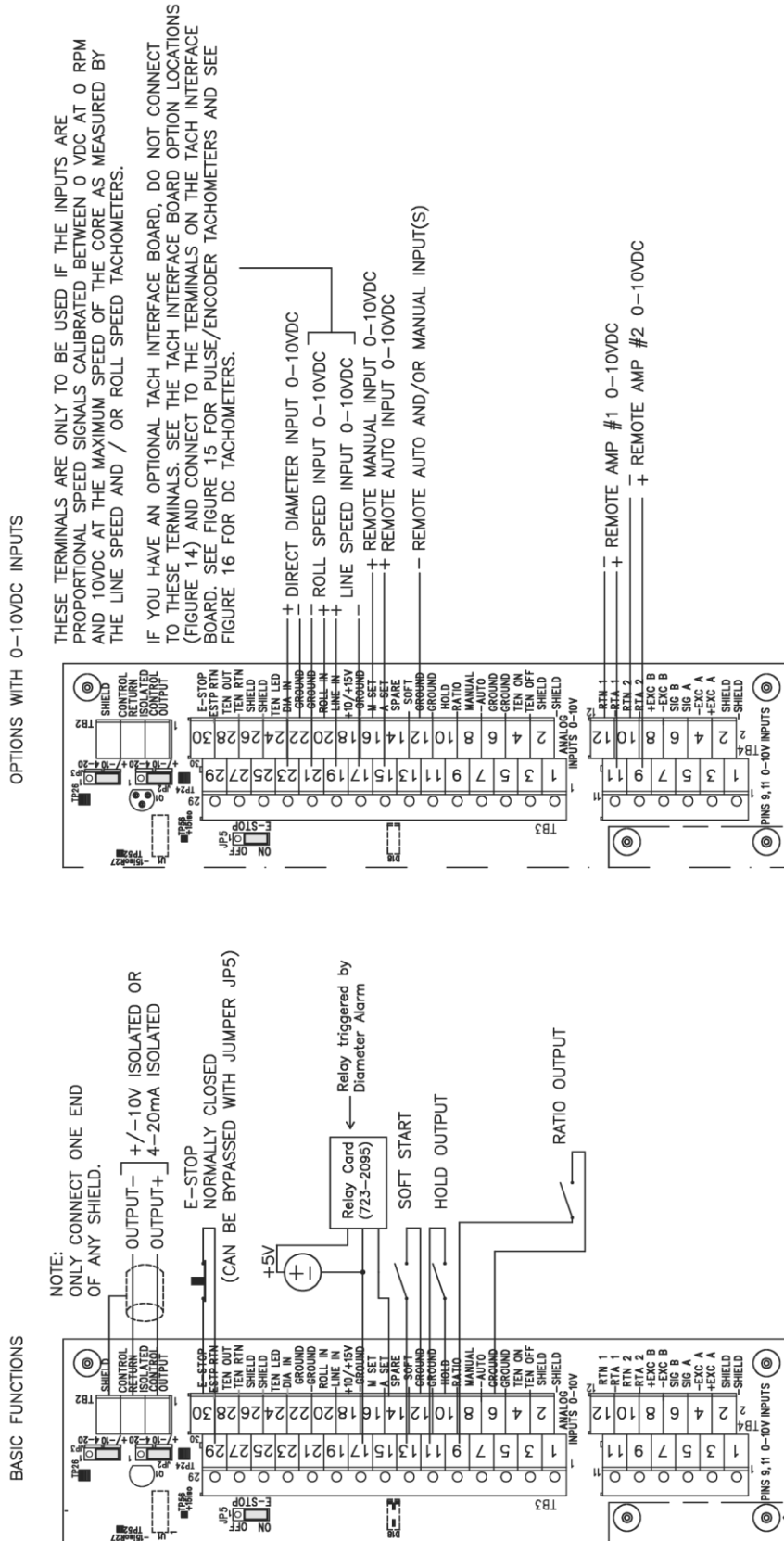


Figure C-1 - STANDARD AND 0-10 VDC CONTROL BOARD ELECTRICAL CONNECTIONS

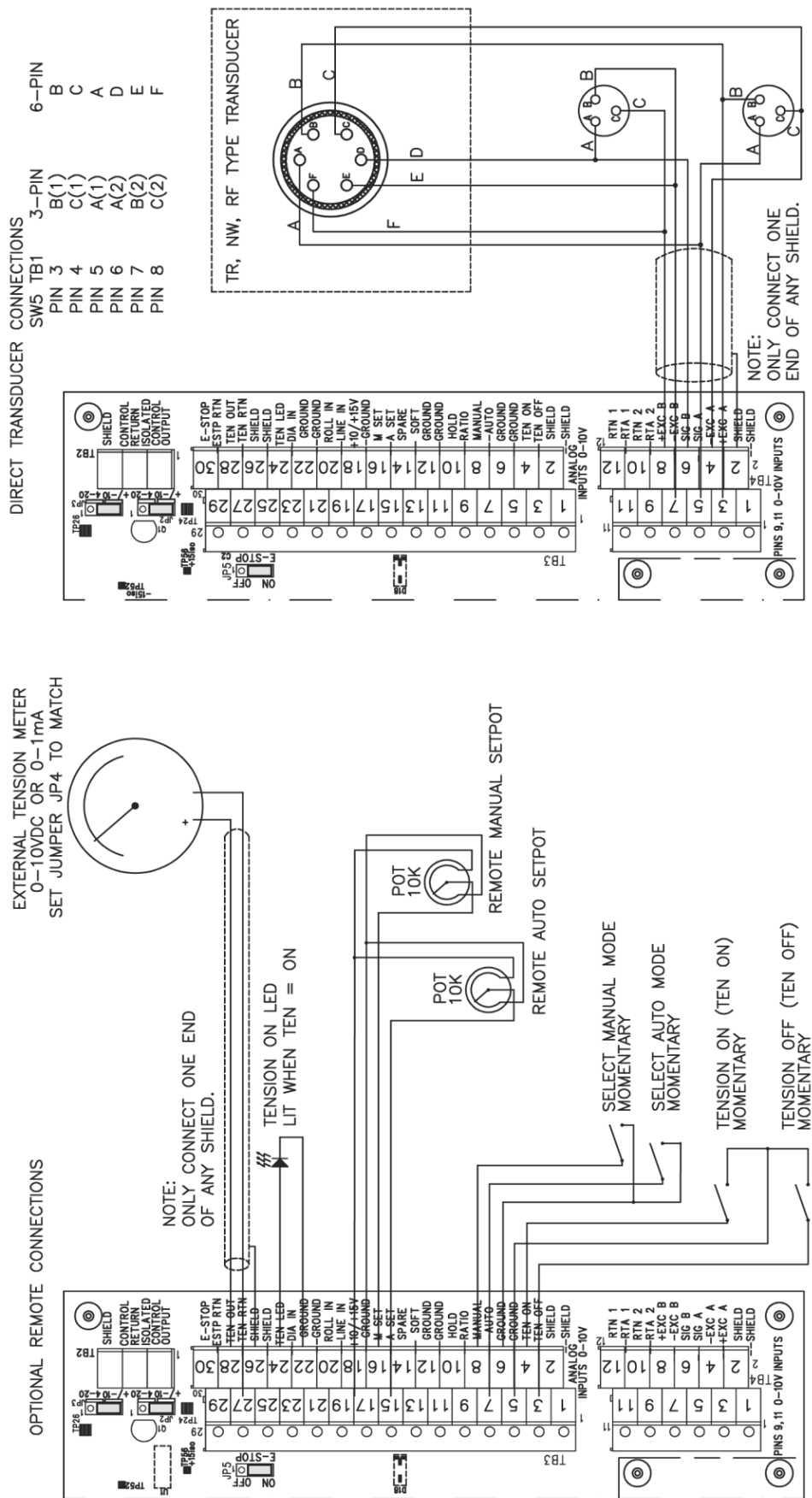


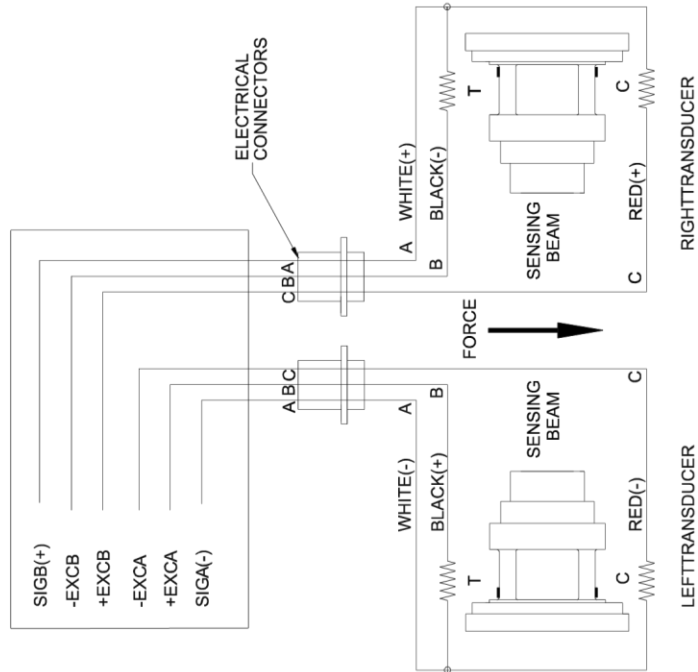
Figure C-2 - CONTROL BOARD TRANSDUCER ELECTRICAL CONNECTIONS AND REMOTE OPTION



# APPENDIX D: TRANSDUCER ELECTRICAL CONNECTIONS

## MODELS C, RS AND F TRANSDUCERS

THE TENSION (T) AND COMPRESSION (C) STRAIN GAGES ARE CONNECTED IN A BRIDGE CONFIGURATION. AS THE BEAMS BEND SLIGHTLY UNDER WEB TENSION, THE GAGE RESISTANCES CHANGE PRODUCING AN OUTPUT SIGNAL WHICH IS DIRECTLY PROPORTIONAL TO THE WEB TENSION.



## TENSION ROLL (TR) AND NARROW WEB (NW) TRANSDUCERS

THE TENSION (T) AND COMPRESSION (C) STRAIN GAGES ARE CONNECTED IN A BRIDGE CONFIGURATION. AS THE BEAMS BEND SLIGHTLY UNDER WEB TENSION, THE GAGE RESISTANCES CHANGE PRODUCING AN OUTPUT SIGNAL WHICH IS DIRECTLY PROPORTIONAL TO THE WEB TENSION.

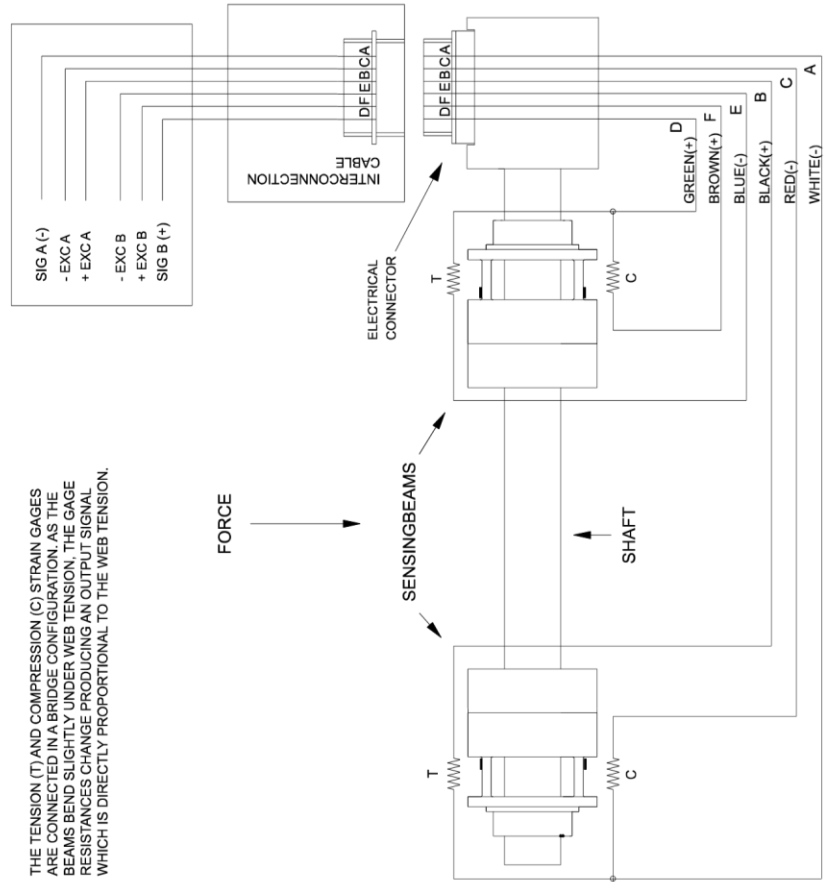
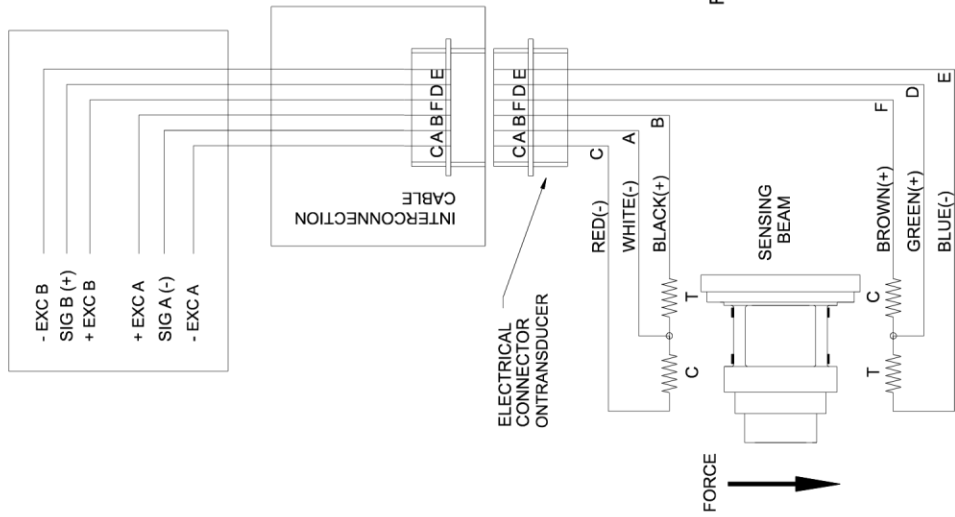


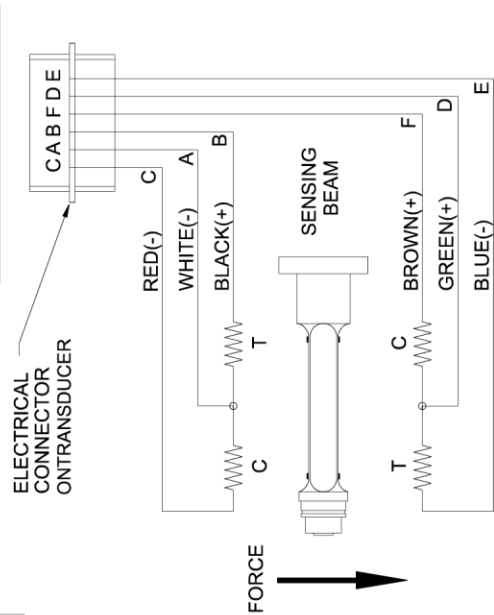
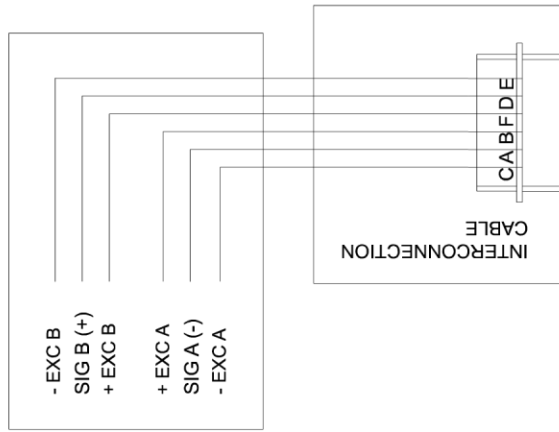
Figure D-1 - MODELS C, RS, F, TR, & NW TRANSDUCER WIRING

### RIBBON FILAMENT (RFA) TRANSDUCERS

THE TENSION (T) AND COMPRESSION (C) STRAIN GAGES ARE CONNECTED IN A BRIDGE CONFIGURATION. AS THE BEAMS BEND SLIGHTLY UNDER WEB TENSION, THE GAGE RESISTANCES CHANGE PRODUCING AN OUTPUT SIGNAL WHICH IS DIRECTLY PROPORTIONAL TO THE WEB TENSION.



### LOW TENSION (LT) TRANSDUCERS



### VERY NARROW WEB (VNW) TRANSDUCERS

THE TENSION (T) AND COMPRESSION (C) STRAIN GAGES ARE CONNECTED IN A BRIDGE CONFIGURATION. AS THE BEAMS BEND SLIGHTLY UNDER WEB TENSION, THE GAGE RESISTANCES CHANGE PRODUCING AN OUTPUT SIGNAL WHICH IS DIRECTLY PROPORTIONAL TO THE WEB TENSION.

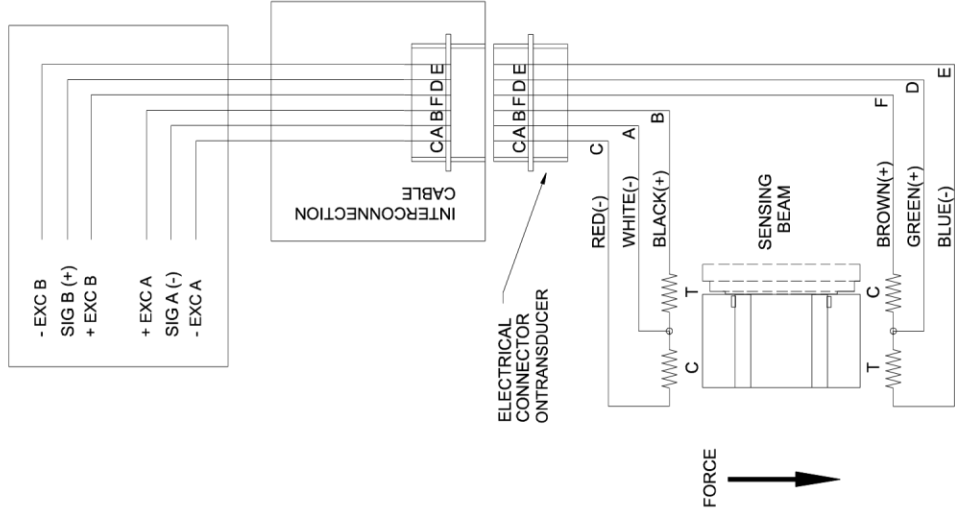


Figure D-2 - MODELS RFA, LT, & VNW TRANSDUCER WIRING

## APPENDIX E: TYPICAL TENSION FOR VARIOUS MATERIALS

TYPICAL TENSIONS FOR WEB MATERIALS			
<b>ACETATE</b>		0.5 lb. per mil per inch of width	
<b>FOIL</b>	<b>Aluminum</b>	0.5 lb. per mil per inch of width	
	<b>Copper</b>	0.5 lb.	"
<b>CELLOPHANE</b>		0.75 lb.	"
<b>NYLON</b>		0.25 lb.	"
<b>PAPER</b>	15 lb *	0.4 lb. per inch of width	
	20 lb	0.5 lb.	"
	30 lb	0.75 lb.	"
	40 lb	1.25 lb.	"
	60 lb	2.0 lb.	"
	80 lb	3.0 lb.	"
	100 lb	4.0 lb.	"
	* based on 3000 sq. ft. ream		
<b>PAPERBOARD</b>	8pt	3.0 lb. per inch of width	
	12pt	4.0 lb.	"
	15pt	4.5 lb.	"
	20pt	5.5 lb.	"
	25pt	6.5 lb.	"
	30pt	8.0 lb.	"
<b>POLYETHYLENE</b>		0.12 lb. per mil per inch of width	
<b>POLYESTER (Mylar)</b>		0.75 lb.	"
<b>POLYPROPYLENE</b>		0.25 lb.	"
<b>POLYSTYRENE</b>		1.0 lb.	"
<b>RUBBER</b>	<b>GAUGE</b>	<b>AT 25% STRETCH</b>	<b>AT 50% STRETCH</b>
	10 mil	1.75	3.68
	12 mil	1.10	2.03
	16.5 mil	4.09	8.17
	26 mil	2.47	4.97
<b>SARAN</b>		.15 lb. per mil per inch of width	
<b>STEEL</b>	<b>GAUGE - INS</b>	<b>UNWIND-PSI</b>	<b>REWIND-PSI</b>
	.001 -.005	1000	4000
	.006 -.025	850	3500
	.026 -.040	750	3000
	.041 -.055	650	2600
	.058 -.070	550	2200
	.071 -.090	450	1800
	.091 -.120	450	1400
	.121 -.140	400	1200
	.141 -.165	400	1000
	.166 -.200	400	900
	.201 -.275	400	800
	.276 -.380	300	700
<b>VINYL</b>		0.05 lb. per mil per inch of width	

\*\*\* For laminated webs, sum the tension for the individual webs and add 0.1 lb per inch width.

## APPENDIX F: ENVIRONMENTAL TERMS

---

**OVERVOLTAGE CATEGORY:** Classification of parts of installation systems or circuits with standardized limits for transient overvoltages, dependent on the normal line voltage to earth.

**POLLUTION:** Any addition of foreign matter, solid, liquid or gaseous (ionized gases), that may produce a reduction of dielectric strength or surface resistivity.

**POLLUTION DEGREE 2:** Normally only non-conductive POLLUTION occurs. Occasionally, however, a temporary conductivity caused by condensation must be expected.

# LIST OF ILLUSTRATIONS

---

- 1-1. SteadyWeb 6™ User Interface
- 1-2. Locations of Toggle Buttons/Indicators in Display
- 1-3. Screen Showing Side Arrows
- 1-4. Analog Meter Display
- 1-5. Trend Line Graph Display
- 1-6. Main Menu
- 2-1. Display Configuration Menu
- 2-2. Select Location to Store
- 2-3. Name Setup Screen
- 2-4. Confirm Save Setup
- 2-5. Recall Setup
- 2-6. Select Setup to Delete
- 2-7. Adjusting Setpoint
- 2-8. Enable Taper Tension
- 2-9. Set Taper Percentage
- 2-10. Taper Setpoint on Meter
- 2-11. Taper Display on Trendline
- 2-12. Examples of When to Run Taper
- 2-13. TLS Setpoint Shown
- 2-14. Reset TLS Screen
- 2-15. Resetting Diameter Alarm
- 3-1. Front View of SteadyWeb 6™
- 3-2. Examples of Tension Zones
- 4-1. Enclosure Version Dimensions and Views
- 4-2. Panel Version Dimensions and Views
- 4-3. Pneumatic Enclosure Dimensions for Version P
- 4-4. High Voltage Output Enclosure Dimensions for Version V
- 4-5. Enclosure Version Service Access
- 4-6. Output Jumpers
- 4-7. Setup Jumpers
- 4-8. 24 VDC Power Electrical Connections
- 4-9. AC Power Electrical Connections
- 4-10. Standard and 0-10VDC Control Board Electrical Connections
- 4-11. Control Board Transducer Electrical Connections and Remote Option
- 4-12. Option Card Mounting Locations
- 4-13. Pulse Tachometer Electrical Connections
- 4-14. DC Tachometer Electrical Connections
- 4-15. Relay Electrical Connections
- 4-16. 24 VDC Connections for Brakes and Clutches
- 4-17. External Output Module Cable Connections
- 4-18. High Voltage Output Module Electrical Connections
- 5-1. SteadyWeb 6™ User Interface
- 5-2. Main Menu Screen
- 5-3. PID Tune View Screen
- 6-1. Selection of Tension Units
- 6-2. Selection of Tension Range
- 6-3. Selection of Tension Source
- 6-4. Selection of Calibration Weight
- 6-5. Selection of Transducer Type

- 6-6. Review of Calibration Settings
- 6-7. Zero Transducer Screen
- 6-8. Zero Operation Complete
- 6-9. Web Path For Calibration
- 6-10. Cal Not Ready
- 6-11. Cal Ready
- 6-12. Cal Successful
- 6-13. DC Tachometer
- 6-14. Pulse Tachometer
- 7-1. Anti-Tamper Lockup Jumper
- 8-1. Tuning Screen Showing Overshoot
- 8-2. Tuning Screens Showing Adjustment Responses
- 8-3. Derivative Noise
- 8-4. Screens Showing Wobble
- 8-5. Diameter Compensation PID Transition
- A-1. Control Board Showing Jumper Locations
- B-1. Menu Hierarchy
- C-1. Standard and 0-10 Vdc Control Board Electrical Connections
- C-2. Control Board Transducer Electrical Connections and Remote Option
- D-1. Models C, RS, F, TR, and NW Transducer Wiring
- D-2. RFA, LT, and VNW Transducer Wiring

## **TERMS AND CONDITIONS OF SALE AND SHIPMENT**

---

See [www.dfe.com/terms-and-conditions/](http://www.dfe.com/terms-and-conditions/) for current Terms and Conditions.



307 PICKERING ROAD  
ROCHESTER, NEW HAMPSHIRE 03867-4630  
U.S.A

TEL: 603-332-6150  
FAX: 603-332-3758

E-mail: [info@dfecom](mailto:info@dfecom) Internet: [www.dfecom](http://www.dfecom)

CANADA

EUROPE

MEXICO

UNITED KINGDOM

TAIWAN

KOREA

CHINA

INDIA

AUSTRALIA

SOUTH AFRICA