



THE TENSION CONTROL SPECIALISTS

INSTRUCTION MANUAL



EtherNet/IP™ Tension Amplifier Model TA500-EIP

DOC 801-2578

Dover Flexo Electronics
307 Pickering Road
Rochester, NH 03867- 4630
U.S.A.

FOR ASSISTANCE:

TECHNICAL SERVICE - Installations, Start-Up, Troubleshooting, Repairs, Field Service or Returns. **Call (603) 332-6150 and ask for Technical Support or email us at: techsupport@dfc.com**

CUSTOMER SERVICE - Replacement Parts, Individual Products, Questions about Orders, Manuals. **Call (603) 332-6150 and ask for Customer Service or email us at: customerservice@dfc.com**

SALES - Product Information, System Application Questions or Placing Orders, **Please e-mail us at: sales@dfc.com or call (603) 332-6150 and ask for Sales.**

Telephone: (603) 332-6150 Fax: (603) 332-3758

E-mail: info@dfc.com Internet: www.dfc.com

SAFETY



This label indicates: “Read The Manual”

Make sure you read and understand all instructions and safety precautions listed in this manual before installing or operating your TA500-EIP Tension Amplifier. If you have any questions concerning the operation of your device or the information in this manual, please contact us.

Email: techsupport@dfc.com
Telephone: (603) 332-6150

- **Observe all warning labels.**
- **Never remove warning labels.**



WARNING: If this equipment is not connected or operated in the manner specified, the operating safety of this unit or of connected equipment cannot be guaranteed.



WARNING: When working with TA500-EIP follow the instructions below and read the manual carefully to protect yourself from injury and the TA500-EIP from damage.



WARNING: Do not open the housing.



WARNING: Protect the TA500-EIP from shocks and vibrations.



WARNING: The TA500-EIP may become warm during normal use. Always allow adequate ventilation around the TA500-EIP and use care when handling.



WARNING: Do not operate the TA500-EIP adjacent to heat sources and do not expose it to unnecessary thermal radiation. Ensure an ambient temperature as specified in the technical data.

Table of Contents

DOCUMENT CONVENTIONS	1
1 GENERAL DESCRIPTION	2
1.1 FEATURES.....	2
1.2 SPECIFICATIONS	2
1.3 DIMENSIONS:	3
1.4 HARDWARE IDENTIFICATION	4
1.5 STATUS LEDs.....	4
2 INSTALLATION & MOUNTING	6
3 STANDARD ELECTRICAL CONNECTIONS	7
3.1 POWER INPUT CONNECTIONS	7
3.2 SIGNAL OUTPUT CONNECTIONS 0-10V, 4-20MA.....	7
3.3 TRANSDUCER LOAD CELL CONNECTIONS	7
3.4 ETHERNET PORT 1 & 2 CONNECTIONS	8
4 CALIBRATION	9
4.1 WEB PAGE INTERFACE CALIBRATION.....	10
4.2 CALIBRATION USING THE ETHERNET/IP INTERFACE.....	13
4.2.1 In program Calibration	13
4.2.2 Parameter Calibration.....	14
5 ESTABLISHING ETHERNET/IP COMMUNICATIONS	14
5.1 EDS FILE.....	14
5.2 INSTALLING THE EDS FILE.....	14
5.3 SYSTEM CONFIGURATION WITH STUDIO5000.....	17
5.4 TENSION DATA AND STATUS.....	19
6 SENDING COMMANDS	22
6.1 FINDING THE IP ADDRESS	22
6.2 MODIFYING THE IP ADDRESS	23
6.3 CHECKING ACTIVE CONNECTIONS	24
7 TERMS AND CONDITIONS OF SALE AND SHIPMENT	25

DOCUMENT CONVENTIONS

NOTICE **NOTES** - Highlight important concepts, decisions you must make, or the implications of those decisions.



CAUTIONS - Tell you when equipment may be damaged if the procedure is not followed properly.



WARNINGS - Tell you when people may be injured, or equipment may be damaged if the procedure is not followed properly.

Numbered lists indicate tasks that should be carried out in sequence:

1. First do this
2. Then do this

Bulleted lists are used for:

- Tasks that can be carried out in any order
- Itemized information

1 GENERAL DESCRIPTION

TA500-EIP is a Tension Amplifier with Quik-Cal™ push-button zero and calibration. In addition, this tension amplifier provides a tension transducer interface with an EtherNet/IP™ connection. It can be used with any DFE tension transducer (load cell) to monitor tension in any zone on web or filament processing machinery. This device accepts commands and allows tension monitoring over an Ethernet connection using the EtherNet/IP™ protocol.

Legacy push button calibration is supported to allow fast commissioning. With this method machine builders will find the TA500-EIP very familiar to existing DFE tension amplifiers. Once calibrated, the amplifier will provide a simultaneous tension signal out in the format of 0-10V and 4-20mA. Optionally an EtherNet/IP™ connection can be established and the tension data will be available through the EtherNet/IP™ connection. For the more advanced users, commands such as calibration, push-button lockout and additional diagnostics are available to facilitate sophisticated machine integration for next generation tension control or monitoring tasks.

1.1 FEATURES

- Quik-Cal™ push-button zero and calibration eliminates pot adjustments to make calibrating simple and fast.
- 10% or 25% Calibration Ratio: Full scale output when tension is at 10 or 4 times the calibration weight.
- DIN Rail Clip compatible with 35mm DIN rail.
- Dual Tension Outputs: Simultaneous 0-10 VDC and 4-20 mA proportionate outputs for connection to a PLC, drive, display meter or data logging device.
- Tension data provided over EtherNet/IP™ connection.
- Calibration / Button lockout commands via EtherNet/IP™ connection.
- Web interface for configuration and calibration options / functions.
- Integral two port Ethernet switch simplifies network cabling.
- DLR interface eliminates single point failures in EtherNet/IP™ environments.
- Integration and remote troubleshooting capability reduce total system and support costs.

1.2 SPECIFICATIONS

Power Input: Voltage: 24 VDC +/- 10%, Current: 0.15 Amps DC typical, internal fusing PTC resettable

Temperature Range: 0°C to 40°C

Network Interface: 10/100baseT. Two switched ports. Supports EtherNet/IP™, EtherNet/IP™-DLR

Network Connectors: Shielded RJ45

Status LEDs: 3 Bicolored LEDs - See [Status LEDs](#) section

Tension Amplifier Accuracy: +/- 1/2% drift at ambient maximum

Tension Outputs: Output 1: 0-10 VDC isolated from 24 VDC input GND

Output 2: 4-20 mA isolated from 24 VDC input GND

Calibration Range: Up to 50:1

Host Processor: 32 Bit

Resolutions: ADC – 24 Bit (16 Bit effective), DAC - 4,096 (12 Bit)

Weight: .25 lbs (114g)

Physical Dimensions: 3.71" (94.22mm) x 1.01" (25.76mm) x 3.70" (94.10mm)

Certifications: ODVA, CE

1.3 DIMENSIONS

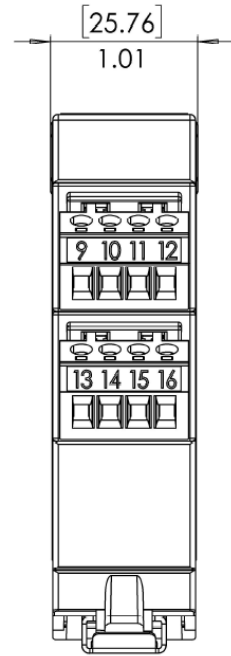
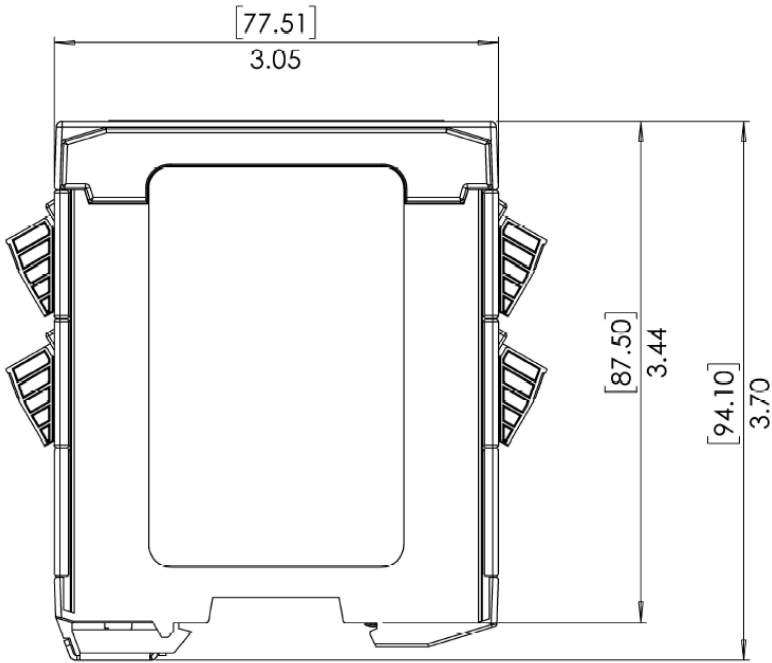
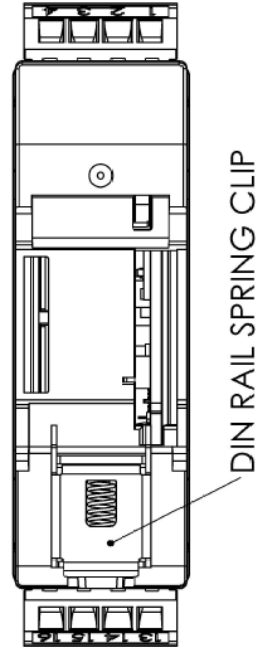
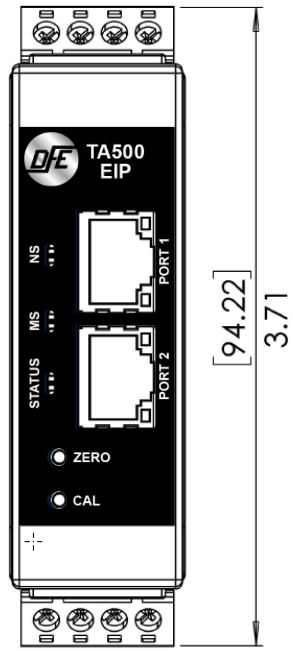

1.4 HARDWARE IDENTIFICATION

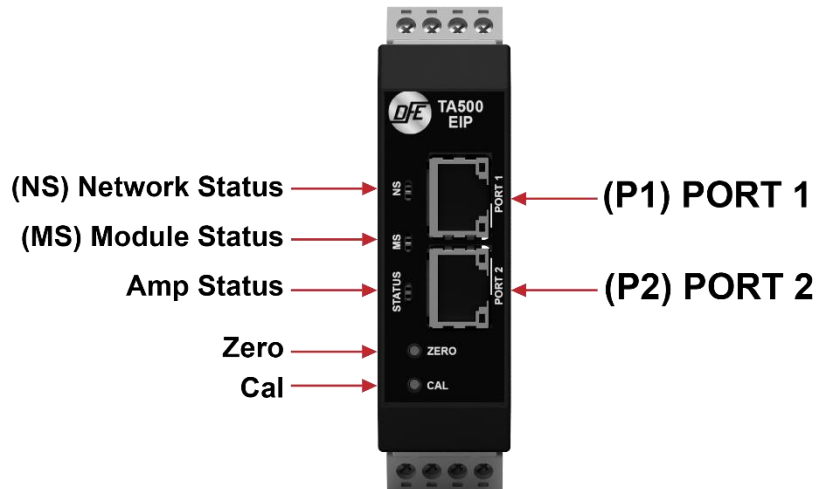

1.5 STATUS LEDs

Amplifier Status Information is useful for determining the condition of the tension amplifier and its network and module operational state. Three bi-colored LEDs located on the front of the TA500-EIP provided this information.

Amplifier Status LED

The Amplifier Status LED is a bi-color red/green LED. The state of the LED depends on the state of the amplifier module. Wiring faults and/or overload conditions of transducer loadcells are indicated and can be decoded using the table below. During normal operation, the status LED is showing a solid steady green. The amplifier status information is also available of the data interface.

STATUS LED STATE	DEFINITION
OFF	Power off.
Steady Green	Normal operation.
Green, 1 Flash	Device not calibrated.
Green, 2 Flash	Over Range Condition: Once calibrated the TA500-EIP will indicate an over range or under range condition by setting the error code to 'Outside Cal Range'. The error is active once -20% or 120% tension is exceeded - Action Required: To clear this error the tension must be brought back into range, or a new calibration will need to be performed to do so.
Red, 3 Flash	Wiring Error: Will alert until the load cells are wired correctly - Action Required: Check wiring and retry. Check for loose wires at the terminal blocks, check for shorts, and be sure the load cells are connected. If the transducers need trouble shooting – contact tech support for assistance. Overload Condition (LT Transducer): Will intermittently alert if overload is reached - Action Required: Check that the tension range does not exceed the transducer load rating. Reduce wrap angle to reduce effective net force exerted on load cell.
Red, 4 Flash	Excitation Failure or Wiring Error - Action Required: Check for shorts in the transducer / load cell wiring. If the transducers need trouble shooting – contact tech support for assistance.
Red, 5 Flash	Internal Failure - Action Required: Contact DFE for replacement.

Module Status (MS) LED

The Module Status LED is a bi-color red/green LED. The state of the LED depends on the state of the network adapter module.

MS LED STATE	DEFINITION
OFF	Power off.
Steady Green	Device in operation.
Flashing Green	Standby device, not configured, no IP address assigned.
Flashing Red	Major recoverable fault.
Steady Red	Major unrecoverable fault, device not operational.
Flashing Green/Red	Self-test at power on.

Network Status (NS) LED

The Network Status LED is a bi-color red/green LED. The state of the LED depends on status of the CIP (Common Industrial Protocol) connection.

NS LED STATE	DEFINITION
OFF	Power off or no IP address configured.
Flashing Green	Device not connected: An IP address is configured, but no CIP connections are established.
Steady Green	Device connected: An IP address is configured, at least one CIP connection is established.
Steady Red	Error: The device has detected that its IP address is already in use.
Flashing Red	One or more connections timed out (CIP Class 1 or 3)
Flashing Green/Red	Self-test at power on.

2 INSTALLATION & MOUNTING

The unit is DIN rail mountable, compatible with 35mm DIN rails. To install snap on to DIN rail. To remove from the DIN rail, use a screwdriver and release the clamp at bottom of the unit as shown below.

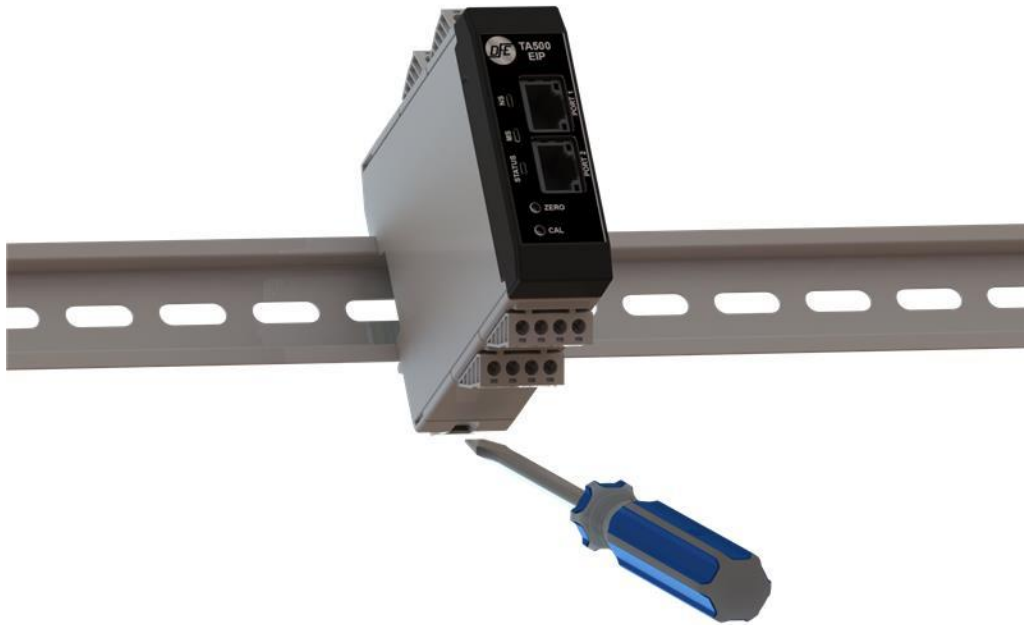

TA500 Devices shall be vertically mounted. Spacing of 1 inch (25.4mm) should be allowed between devices. Zero stacking (no clearance between units) is not allowed due to the potential for overheating. Care should be taken to observe the ambient operation conditions and avoid subjecting the unit to excessive adjacent heat sources and/or unnecessary thermal radiation. Maintain an ambient temperature range as specified in the technical data to ensure reliable operation.

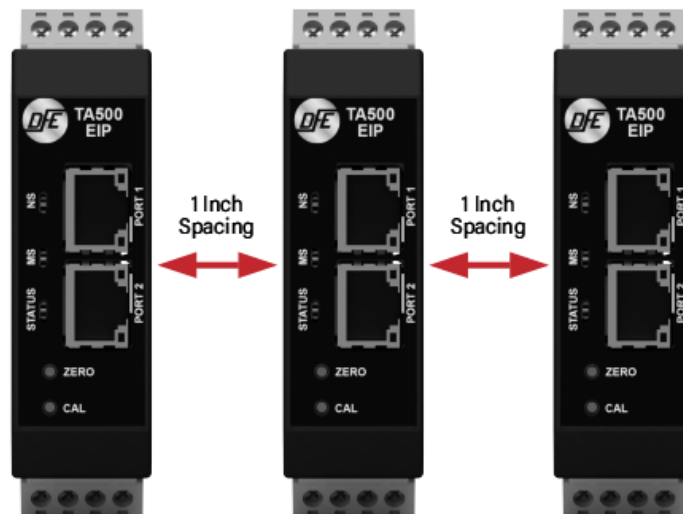

3 STANDARD ELECTRICAL CONNECTIONS

! CAUTION – Use care when wiring as incorrect wiring can cause damage to the unit.

3.1 POWER INPUT CONNECTIONS

- Pin 1: Power GND
- Pin 2: +24 VDC
- Pin 3: No connect
- Pin 4: Shield (Tied to Functional Earth Ground Connection)

3.2 SIGNAL OUTPUT CONNECTIONS 0-10V, 4-20MA

- Pin 5: Signal GND
- Pin 6: No connect
- Pin 7: Output 1 - V OUT 0-10 V
- Pin 8: Output 2 - I OUT 4-20 mA

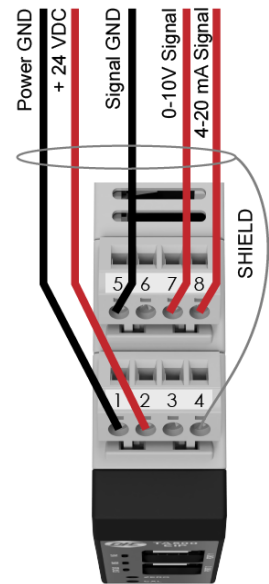

3.3 TRANSDUCER LOAD CELL CONNECTIONS

- Pin 9: - SIGNAL
- Pin 10: - EXCITATION
- Pin 11: + EXCITATION
- Pin 12: Shield (Tied to Functional Earth Ground Connection)
- Pin 13: + SIGNAL
- Pin 14: + EXCITATION
- Pin 15: - EXCITATION
- Pin 16: Shield (Tied to Functional Earth Ground Connection)

Transducer Connections
MODEL C, F

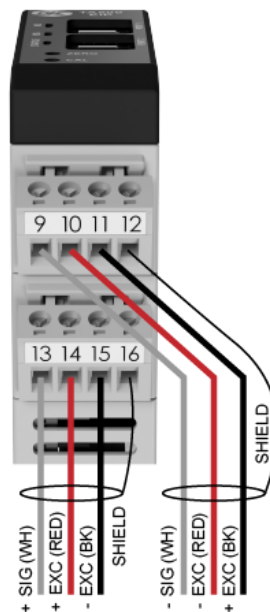

Transducer Connections
TR / NW / RFA / LT / VNW

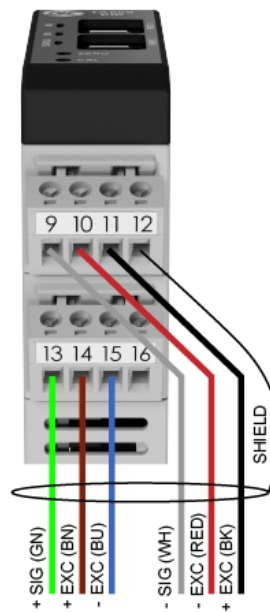

NOTICE TA500-EIP meets the European Union's Low Voltage Directive and EMC Directive only when installation is done correctly. To meet the EMC Directive, a proper transducer installation, including shielded cables must be used.

Functional Earth Connection

A functional earth connection is provided to make contact with the DIN rail. Functional earth is a current path of low impedance between current circuits and earth, which is used to maximize interference immunity.



NOTICE Connect the mounting rail to functional earth potential. Please note that the impedance of the connecting cable has to be kept low.

3.4 ETHERNET PORT 1 & 2 CONNECTIONS

Non-DLR Applications:

Ethernet connections are made to the Ethernet interface via RJ45 connections. The TA500-EIP unit has two Ethernet ports with a built-in Ethernet switch capable of supporting DLR (Device Level Ring). In non-DLR applications, either port can be used to attach the unit to the network. The remaining port can be used to extend the network to another device, potentially reducing wiring costs.

DLR Applications:

DLR provides a means to detect, manage, and recover from single faults in a ring-based network. In Device Level Ring applications, the TA500-EIP unit functions as a Beacon-Based Ring Node. In these applications, both ports are used when wiring the ring, daisy chaining from one unit in the ring to the next.

Port1 & Port2 Ethernet Interface RJ45 connectors Details:

The Ethernet interface capability is 10/100Mbit, full or half duplex operation. Ethernet cord set is recommended to be CAT-5 cable, shielded (STP). The pinout connection is standard and is provided below for reference.

Pin no	Description
4,5,7,8	Connected to chassis ground over serial RC circuit
6	RD-
3	RD+
2	TD-
1	TD+
Housing	Cable Shield

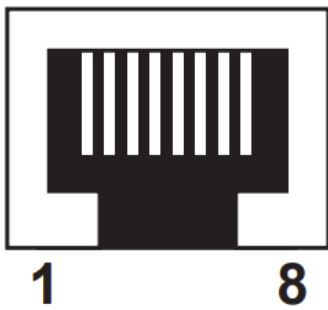

4 CALIBRATION

A calibration process must be performed before your amplifier is ready to indicate tension. The following should already be completed prior to calibration.

- Attach power connection to the unit
- Attached the Transducer Load cell connections
- Attached the analog signal output connection if used
- Attached the ethernet data connection if used
- Power the unit
- Status indication of the unit should indicate no status errors, however it may indicate that the device is not calibrated or is in an overloaded condition if the device was previously calibrated – see [status LEDs](#)

NOTICE The TA500-EIP can be used as an amplifier with or without an EtherNet/IP™ connection established.

There are three methods to calibrate the TA500-EIP

- Traditional Push Button Calibration
- Calibration through the web interface
- Calibration through the EtherNet/IP™ interface

NOTICE All three of the above methods require zeroing the amplifier with no weight or load on the transducer load cells. Once zeroed, a calibration weight or load can be applied equal to 10% or 25% of the full range desired.

Traditional Push Button Calibration

This calibration process is easy and produces a unitless proportional 2-point calibration. An appropriate calibration weight will need to be selected. The weight determines the value of web tension that will be produced at full output of the TA500-EIP. The TA500-EIP allows calibration to be performed with 10% or 25% of the full range desired.

For example: A 15 lb weight will result in a scaled range of 0-150 lbs of tension if a 10% calibration is performed. Analog output values of tension are always unitless and proportional to tension.

1. **ZERO:** Ensure nothing is hanging on or pressing on the transducer roll (including the calibration rope). Press the ZERO pushbutton on the unit front panel for at least 1 second. The unit will automatically adjust and store the tension-zero value one second after the button is pressed. The unit will rapidly flash the green status LED to indicate the zero has been stored. Release the button. The Output1 will read 0 VDC and Output2 will read 4 mA.
2. **CALIBRATE:** Hang weight as indicated below. Wait for the weight to stop swinging.

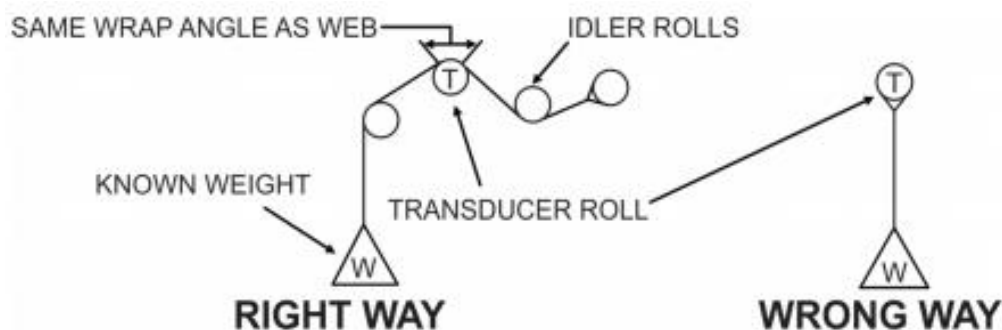

To calibrate at 10%: Push and Hold the Cal Button (About 1 Second) until confirmation blinks, then release the button. The output will read 10% of full scale after calibration.

To calibrate at 25%: Push and Hold Cal Button (About 5 Seconds) until you see two sets of confirmation blinks. Then release the button. The output will read 25% of full scale after calibration.
(If no confirmation blink occurs, inadequate calibration weight may have been used)

After calibration: Remove the weight and observe the output. It should read 0 VDC or 4 mA with nothing touching the tension sensing roller.

NOTICE *Once calibrated, tension data is also available over the network connection, however it should be noted that the calibration performed can be considered unitless and range-less unless the value in the CalRange Register and the CalUnits register at calibration was valid. In this case the TENSION_P may be the most desirable tension register. See [Accessing Tension Data](#) for more information.*

4.1 WEB PAGE INTERFACE CALIBRATION

A web interface is provided to allow easy access to parameters including calibration commands and operational status of the device.

NOTICE *Be sure that when you are setting parameters or sending commands from the web interface that there are no open EtherNet/IP™ connections to the amplifier. This can be verified by checking the Network Status EtherNet/IP™ Statistics or viewing the Network Status LEDs. If there is an established / owned connection which is active, it will likely be continuously overwriting any parameter or command data sent by the Web Interface. To verify that there are no active connections see the section [Checking Active Connections](#).*

Confirm that the TA500-EIP has a valid link to your network and an assigned or specified IP. The default IP address programmed at the factory is 192.168.1.230. If you are unsure what the IP address is see the section [Finding the IP address](#).

Using a standard web browser Navigate to the web interface at a known address.

NOTICE *Credential may be required:*

Username: User

Password: Password

The web interface calibration will allow configuration of the Units and the Range of the calibration providing a Calibrated tension output in addition to a proportional percentage tension output. The units and range have no effect on the voltage or current output signals, as those are always output as a proportional tension value.

Units and Range must be set before the calibration command takes place.

Set the units and range of the calibration:

1. Ensure the transducer load cells are installed in the intended configuration and that nothing, including any rope used to hang calibrations weights, is loading the load cells.
2. Navigate to the web interface of the TA500-EIP and select the parameters page.

MODULE	Identification	
Overview	Module name:	Tension Amplifier TA500-EIP
Parameters	Serial number:	A049AB82
NETWORK	FW version:	1.01
Status	Uptime:	0 days, 3h:27m:28s
Configuration	CPU Load:	2%
	DATA OTHER:	155

3. Find the “CalUnits” parameter and select the desired unit for calibration and press “Set”.

7	CalUnits	lb	▼	Set
---	----------	----	---	------------

4. Find the “CalRange” parameter and select the desired range for calibration and press “Set”.

8	CalRange	100	▼	Set
---	----------	-----	---	------------

Zero:

1. Ensure the transducer load cells are installed in the intended configuration and that nothing, including any rope used to hang calibrations weights, is loading the load cells.
2. Verify the amplifier status is not reporting an error. “AmpStatus” should indicate “Amp OK” or “No Cal”.

1	AmpStatus	Amp OK	▼	
---	-----------	--------	---	--

3. Locate **Parameter 9** “Command” and select the drop down menu option “Zero”.

Command	No Command ▼
CommandResponse	No Command Zero Calibrate 10 Calibrate 25 Lock Unlock Reset Cal Set Gain

4. Then press the “Set” button.

Command	Zero ▼	Set
CommandResponse	Ready ▼	

5. Check the “Command Response” value for success indicated by “Zero OK” at this point the zero operation is complete, proceed to the calibrate step.

NOTICE *If for some reason you need to Zero again be sure to set the command register to ‘No Command’ before sending another zero command. Commands are only processed on transition.*

Calibrate:

During the calibration, the transducer(s) should be loaded. Fasten one end of the rope in the machine and thread the other end around the transducer roll in the same path the web will take. Be sure the rope does not pass around any driven rolls, drag bars, or anything else that can affect tension. Ideally the rope should hit an idler roll immediately before and after the tension sensing roll. It does not have to pass over any other rollers once these three are strung. Attach the weight to the free end of the rope as shown in the Figure Below. The weight should not touch anything. Wait for the weight to stop swinging.

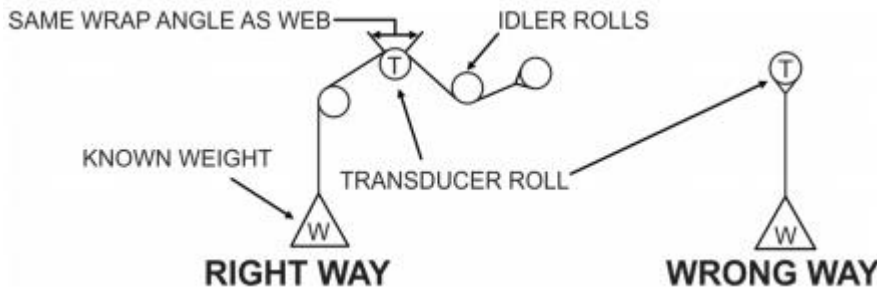

1. locate **Parameter 9** “Command” and select the dropdown menu option “Calibrate 10” (10% calibration) or “Calibrate 25” (25% calibration). For example, lets select a 25% calibration. Using the range and units selected above (100 lb), we should be calibrating with 25% of the full range equal to a weight of 25 lbs. The calibration weight must be hanging before this command is sent.

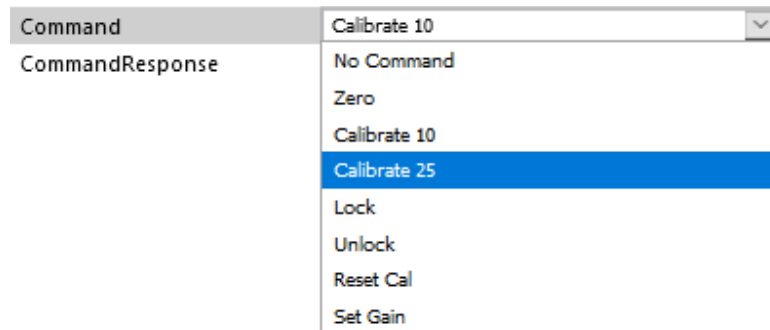

2. Then press the “Set” button.



3. Check for command success or an error condition. An error occurs in the command response after the calibration command only when an insufficient calibration weight condition is detected.

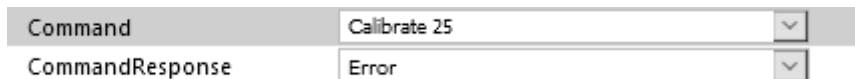

If the command response register indicates success, then the calibration is complete.

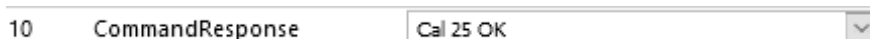

4. Calibration success can be verified by checking the analog outputs or verifying the tension data in the connected interface.

While the calibration weight is still hanging, the tension percent reading shall correspond to the calibration percentage. In the example above, the TensionPercent parameter is read as 25.0 as the register holds the tension value with 1 decimal place format. The CalTension parameter holds the calibrated tension value with 2 decimal places format. The active Units and Range can be verified as well. This page does not auto refresh, and refresh should be done so manually using the refresh button.

#	Name	Value	Refresh
1	AmpStatus	Amp OK	
2	ADCValue	33480	
3	TensionPercent	25.0	
4	CalTension	2500	
5	ActiveUnits	lb	
6	ActiveRange	100	

NOTICE If the calibration command must be sent again, be sure to set the Command to “No Command” before re-sending the calibration command as commands are only processed on transition.

4.2 CALIBRATION USING THE ETHERNET/IP™ INTERFACE

4.2.1 In program Calibration

Using Rockwell Automation Studio 5000 version 20 and above. Be sure that you have a valid EDS file installed for the TA500 and that you have added the TA500 module to your project. See the section [Installing the EDS File](#) and [Adding the Module](#) for more information if needed.

When the module is properly installed, Tags will automatically be assigned in Studio5000 environment to allow easy access to the TA500 registers. For calibration we will use the MOV instruction to copy command instruction values to the TA500:0.COMMAND Register and we can use the TA500:I.Command_Processed bit located in the TA500:I.STATUS_BITS register to identify when the command is complete as the TA500:0.COMMAND should be cleared or set to zero when no command is requested.

Below is a simple ladder logic example of a method exercising commands necessary for calibration of the TA500 from within a program. This can be useful if the designer wants to implement calibration or commissioning process from within a program.

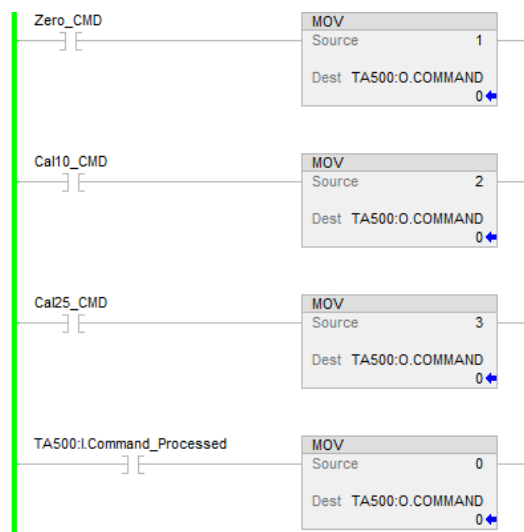

The calibration process is identical to previously discussed calibration methods. Where, as always, the amplifier should be zeroed with no weight hanging on the load cells and calibrated with a weight equal to 10% or 25% of the full weight.

It may be desirable to add units or range information to the calibration. If so, these registers must be set accordingly **before** a calibration command is completed. The registers which must be set are **CAL_UNITS** and **CAL_RANGE**. See the [Output Tags](#) section for more details and information regarding unit and range value definitions.

4.2.2 Parameter Calibration

Alternatively, the parameters for calibration are accessible under the Module Properties.

The parameters can also be used for quick troubleshooting of the device or to aid in commissioning.

ID	Name	Value	Units	Style	Description
1	AmpStatus	Amp OK			
2	ADCValue	33157		Decimal	
3	TensionPercent	0		Decimal	
4	CalTension	0		Decimal	
5	ActiveUnits	lb			
6	ActiveRange	1			
7	CalUnits	g			
8	CalRange	5			
9	Command	No Command			
10	CommandResponse	Ready			

5 ESTABLISHING ETHERNET/IP COMMUNICATIONS

5.1 EDS FILE

The EDS (Electronic Data Sheet) file is provided by Dover Flexo Electronics. Many EtherNet/IP™ platforms support the use of EDS files to simplify the addition and configuration of devices. At the minimum, an **EDS** file conveys the identity information required for a network tool to recognize the device. Using the EDS file simplifies configuration and can add the named tags for all input and output data.

NOTICE This section covers the installation and use of the EDS file for systems that are programmed with Rockwell Automation Studio 5000 version 20 and above. Other systems will follow a similar pattern. Consult your controller's documentation if you need additional information.

NOTICE All Dover Flexo Electronics' EDS files are located on our website at the following address:
<https://dfe.com/products/tension-amplifiers/ta500-eip-tension-amplifier-2/>

5.2 INSTALLING THE EDS FILE

With Studio 5000 running, in the menu bar select Tools -> EDS Hardware Installation Tool. This will open the EDS Wizard.

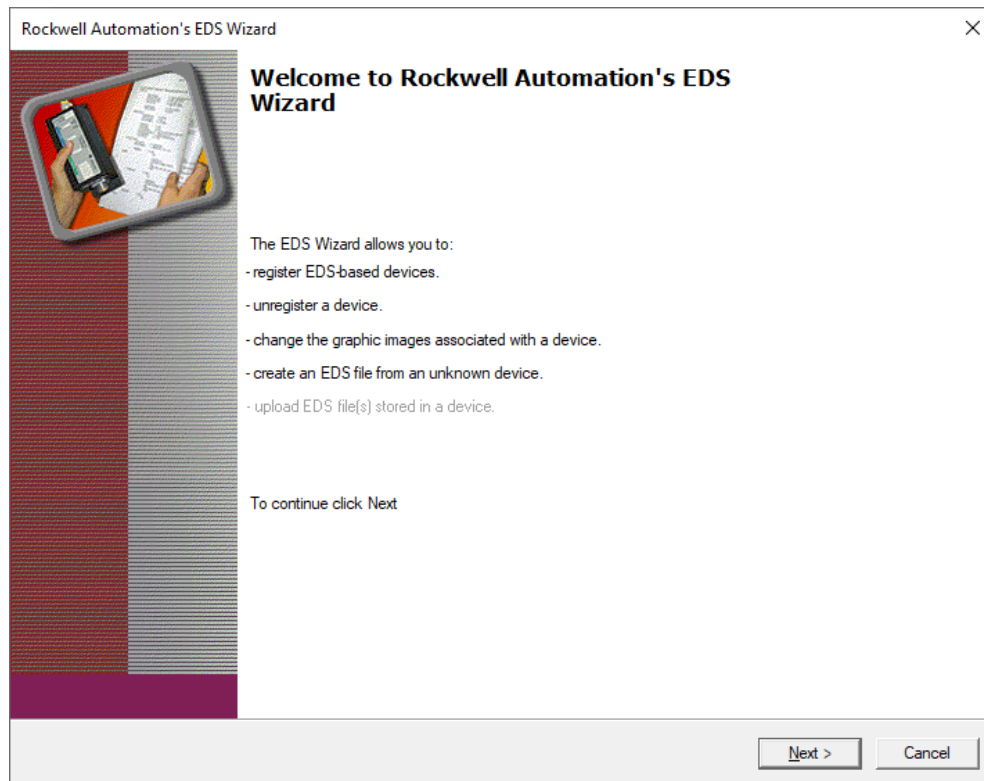
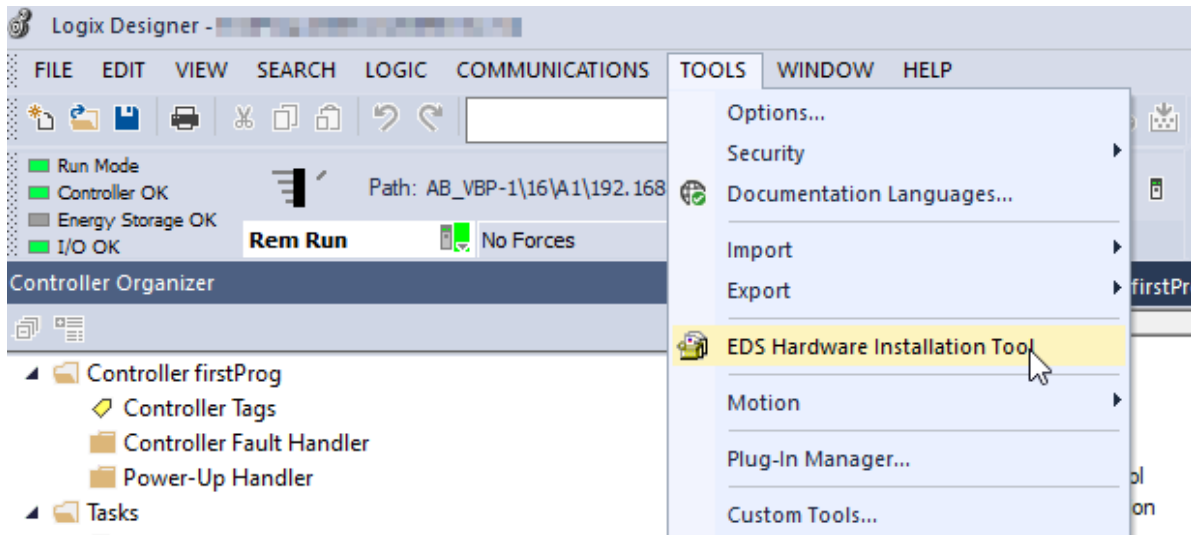

1. Click **next** to continue.

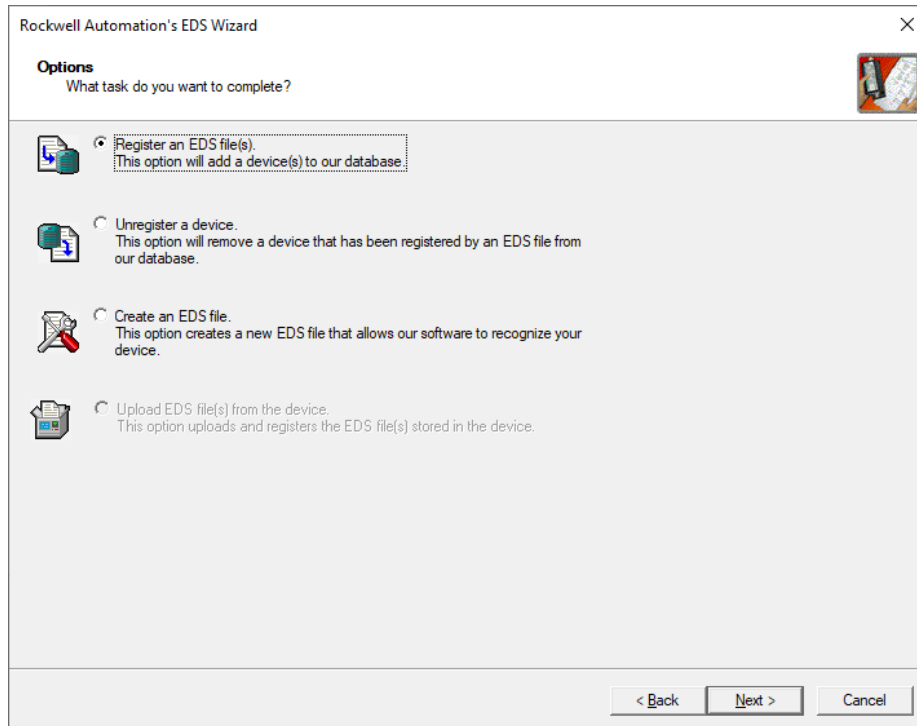

2. Select the “**Register an EDS file(s)**” and click **next**.

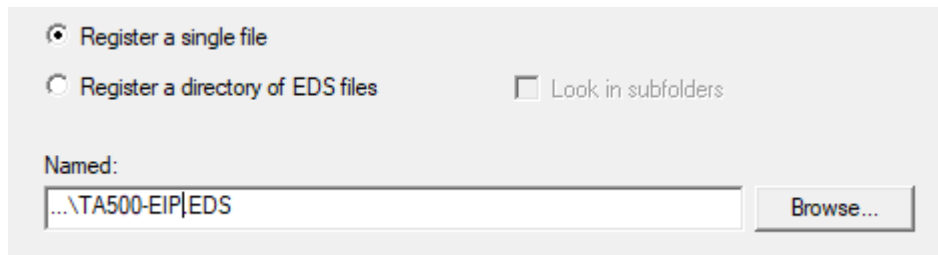

3. Select the “**Register a single file**” and click **next**.

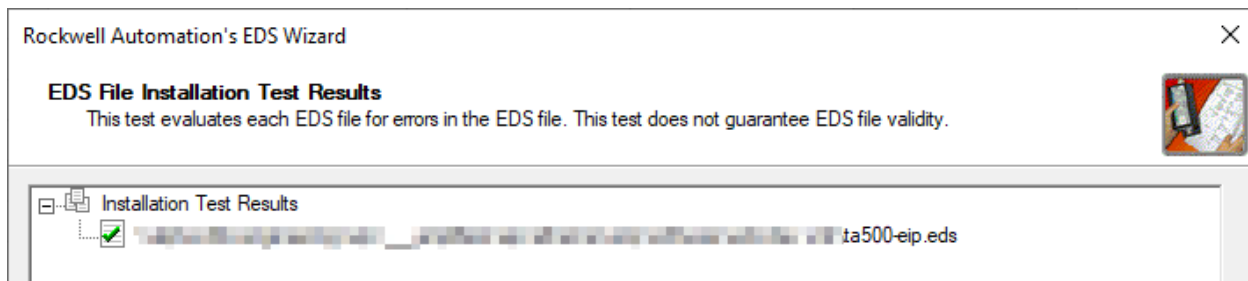

4. The Wizard will show that the import is scanned for errors and is error free. Click **next**.

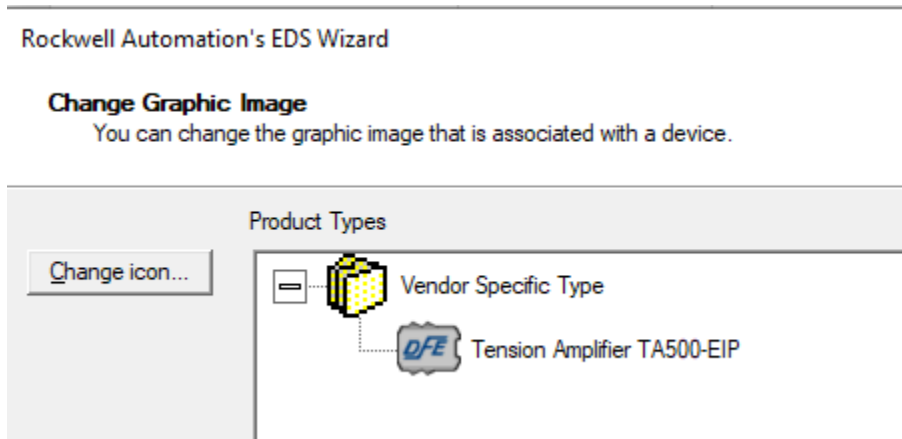

5. Click **Next** unless you want to change the default icon.

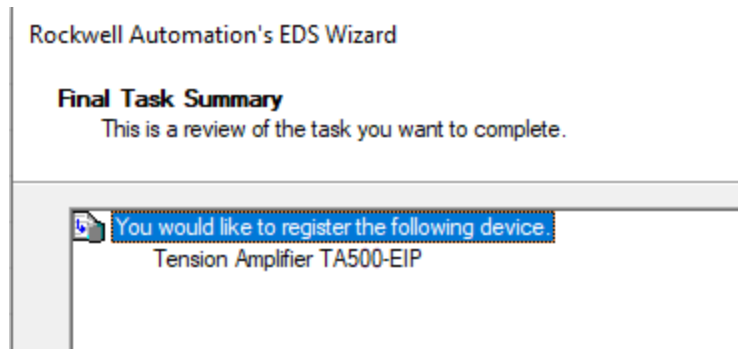

Click **Ok** to add the device. EDS installation is complete.

5.3 SYSTEM CONFIGURATION WITH STUDIO5000

NOTICE This section covers the installation and use of the EDS file for systems that are programmed with Rockwell Automation Studio 5000 version 20 and above.

Adding the Module

1. **Right click** on the Ethernet port and then click on “**New Module...**” in the pop-up menu.

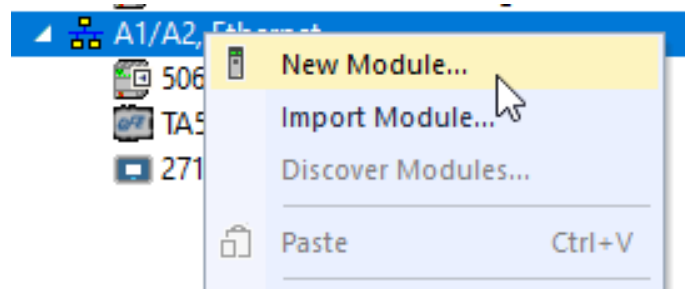

2. Search for “TA500” in the applicable Filters.

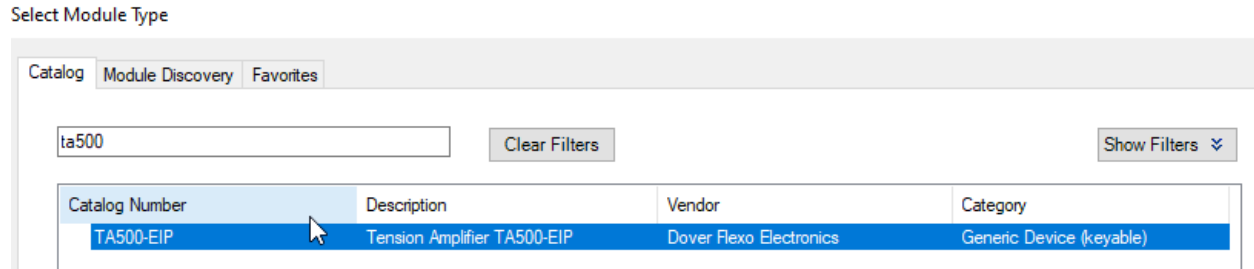

3. Select “Tension Amplifier TA500-EIP” in the resulting list.
4. Click on the [Create] button to create the module.
5. Click on [Close] if necessary, to close the Select Module Type screen
6. Set the IP and Give the Device a name then Press OK.

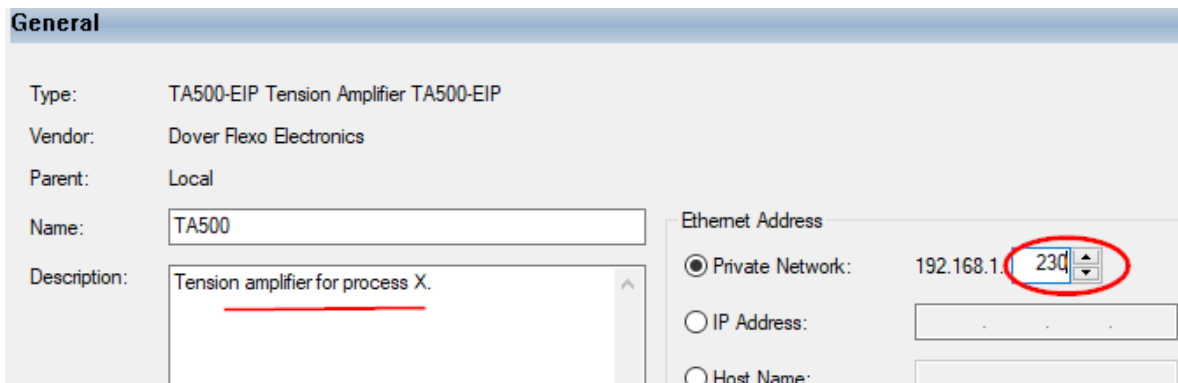

Configuring the Module

Access the properties of the TA500 module. Enumerated values of the status and commands are provided for easy commissioning. A user may choose to calibrate the TA500 using this parameter section or can choose from other methods of calibration, for more info see the section [Calibration](#).

Parameters

Group: <All Parameters> ▾

ID	Name	Value	Units	Style	Description
1	AmpStatus	No Cal			
2	ADCValue	33156		Decimal	
3	TensionPercent	0		Decimal	
4	CalTension	0		Decimal	
5	ActiveUnits	lb			
6	ActiveRange	100			
7	CalUnits	lb			
8	CalRange	100			
9	Command	Reset Cal			
10	CommandResponse	Ready			

5.4 TENSION DATA AND STATUS

After the module is added input Tags carry the calibrated tension value if the unit is calibrated and other status information of the device. If calibration of the unit is required see the section [Calibration](#). All tag data is Signed 32-bit integer value. The input tags descriptions are as follows:

Input Tags:

STATUS_BITS

STATUS_BITS																
31-16	15	14	13	12	11	10	9	8	7	6	5	4	3	2	1	0
RESERVED	AMP_OK	CMD PROCESSED	RESERVED	RESERVED	RESERVED	RESERVED	RESERVED	RESERVED	HEARTBEAT	RESERVED	RESERVED	RESERVED	RESERVED	Zerored At Unit	Calibrated At Unit	Amp Locked

Status	Name	Definition
0	Amplifier locked	No Button access is allowed for zero or calibration
1	Calibrated at unit	Indicates that the last valid calibration was performed using the buttons
2	Zerored at unit	Indicates that the last zero operation was performed using the buttons
3-6	RESERVED	Always Zero
7	Heartbeat Bit	Bit toggles every 0.5 seconds approx.
8-13	RESERVED	Always Zero
14	Command Processed	Bit set High after a command is processed, can be used in ladder logic to reset the command register to zero (no command)
15	AMP OK	SUMMARY Bit indicating no error status.
16-31	RESERVED	Always Zero

AMP_STATUS

Status	Definition
0x00000000	Amplifier OK – Normal Operation
0x00000001	Internal Failure
0x00000002	No calibration
0x00000003	Out of Range – Amplifier is calibrated but is experiencing an overload or underload condition.
0x00000004	A wiring error is detected – in rare occurrences this error could be caused by an extreme overload conditions on load cells.
0x00000005	An error is detected with the excitation of the load cells – usually this means a short circuit is present externally to the amplifier.

ADC_VALUE – Raw value of input signal from load cells. Useful for troubleshooting or by advanced users.

TENSION_P - Tension value in percent of total calibrated range. Format: 1 decimal.

NOTICE *If the calibration was performed using the zero and calibration button on the TA500 then the calibration performed can be considered unitless and range-less unless the value in the CalRange Register and the CalUnits register at calibration was valid.*

TENSION_C - Tension value in the configured unit with 2 decimals.

NOTICE *The configured unit and range must be set prior to calibration and cannot be set after. The calibration process will store the units and range only at the time of calibration.*

ACTIVE_UNITS – This is the units value stored with the calibration.

ACTIVE_RANGE – This is the range value stored with the calibration. For instance, if this value is 9, then the range specified in calibration is 100. See CAL_RANGE in the Output Tags section for the lookup table.

COMMAND_RESP

Value	Definition
0	Ready for Command
1	Zero Completed OK
2	Calibration 10% Completed OK
3	Calibration 25% Completed OK
4	Error – Usually due to insufficient calibration weight

ACTIVE_ZCODE – Internal ADC value latched when the zero operation was completed. These are for advanced users.

ACTIVE_SCODE - Internal ADC value latched when the calibration operation was completed. These are for advanced users.

Output Tags:

CAL_UNITS – If desired the unit type can be stored with the calibration. The data in this tag must be valid when sending the calibration command for the unit to be stored.

Value	Definition
0	"lb" Pounds
1	"oz" Ounces
2	"g" Grams
3	"kg" Killograms
4	"N" Newtons

CAL_RANGE – The calibration range can be stored with the calibration. This data in this tag must be valid when sending the calibration command for the unit to be stored.

Value	Definition
0	1
1	5
2	10
3	15
4	20
5	25
6	35
7	50
8	75
9	100
10	125
11	150
12	200
13	250
14	300
15	400
16	500
17	750
18	1000
19	1250
20	1500
21	2000
22	2500
23	3000
24	4000
25	5000

COMMAND – Commands can be used to Zero and Calibrate the amplifier as well as lockout the front buttons to prevent user interference with a pre-existing calibration. These commands are detailed in the section [Sending Commands](#)

ZERO_VALUE – For advanced users only

SPAN_VALUE – For advanced users only

6 SENDING COMMANDS

Commands are primarily used for calibration of the TA500 via the EtherNet/IP™ interface. If the web interface or the push button method is used for calibration, users can dis-regard this section of the manual if they are not interested in additional features.

Utilizing calibration commands via the EtherNet/IP™ interface can enable machine builders to create a more robust and efficient machine commissioning routine for their customers or builders without the need to physically locate the amplifier and push buttons for legacy calibration techniques. Below is a list of the available commands and their definitions:

VALUE	COMMAND	DEFINITION
0	No Command	No command requested, Idle.
1	Zero Amplifier	Command the TA500 to establish a zero-point, part of the calibration process. This command is always used before a Calibrate 10% or 25% command.
2	Calibrate 10% *	Calibrate the amplifier using a calibration weight equal to 10% of the full range.
3	Calibrate 25% *	Calibrate the amplifier using a calibration weight equal to 25% of the full range.
4	Lock Amplifier	When the amplifier is locked it prevents button operation at the unit, such as zero, calibrate, or reset.
5	Un-Lock Amplifier	When the amplifier is un-locked, buttons at the unit function as described in the manual. (DEFAULT)
6	Reset Calibration	Forces the Amplifier to an un-calibrated state.
7	Set Gain	Gain can be set manually for advanced users.

***Transducer (load cells) should be loaded with appropriate calibration weight before this command is sent**

These commands are used to establish a two-point calibration in the amplifier. During the calibration process the gain is automatically calculated in the amplifier. The [Calibration using the Ethernet/IP Interface](#) section defines how to use calibration commands in more detail.

NOTICE All Commands are processed only on a command transition. The command register should be set to zero when no command is requested and after a command is processed. Users may find the bit 'Command Processed' useful when developing command logic. See the [Input Tags Status Bit](#) section for the bit location.

6.1 FINDING THE IP ADDRESS

If the IP address of the TA500-EIP is unknown, there are a few methods which can be used to find its current IP address or re-establish a default IP.

HMS IPconfig Tool:

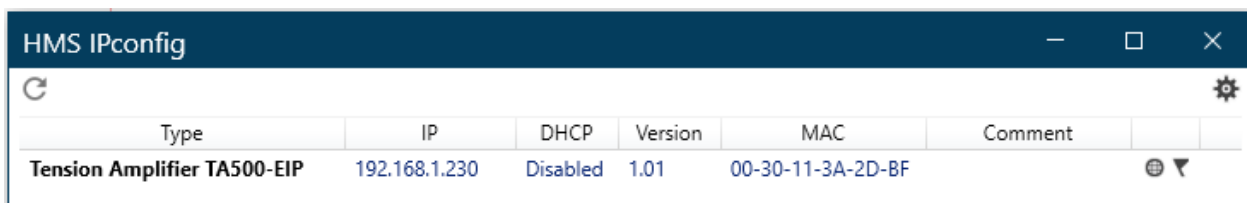

Type	IP	DHCP	Version	MAC	Comment
Tension Amplifier TA500-EIP	192.168.1.230	Disabled	1.01	00-30-11-3A-2D-BF	

The TA500-EIP uses the HMS NP40 chipset for its network processor architecture. HMS provides a tool to locate devices on the network called the HMS IPconfig Tool. It is free to download from HMS Anybus webpages at <https://www.anybus.com/support>

Using this tool makes it easy to view device types and verify network IP configurations.

RSLinx Who Active:

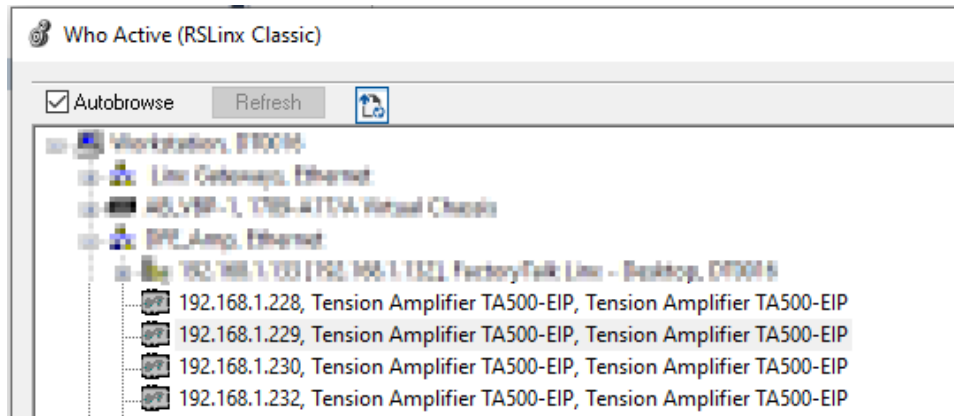

RSWho is RSLinx Classic's main window that shows networks and devices in a style similar to Windows Explorer. It allows you to view all network connections from a single screen. The tool is available from Rockwell Automation. This is a simple way of identifying connected available devices on the network and verifying their associated IP.

6.2 MODIFYING THE IP ADDRESS

The TA500 IP configurations can be modified using several methods. Using the HMS IPconfig Tool, the RSLinx tool from Rockwell Automation or directly on the TA500 web interface.

The IP address of the TA500 can be modified by going to the web interface and navigating to the configuration page. Change the IP to the desired address and click save settings. The IP change will require a power on reset for the change to be effective. The power can be cycled to the device or a Type 0: Power Cycling Reset command can be sent to the Identity Object (01h).

⚠ CAUTION – A type 1 Reset sent to the identity object will result in a device factory reset. The tension calibration will be lost and the IP configuration will default to DHCP.

When using methods such as the HMS IPconfig Tool or RSLinx, no reset is required for the IP configuration changes to take effect.

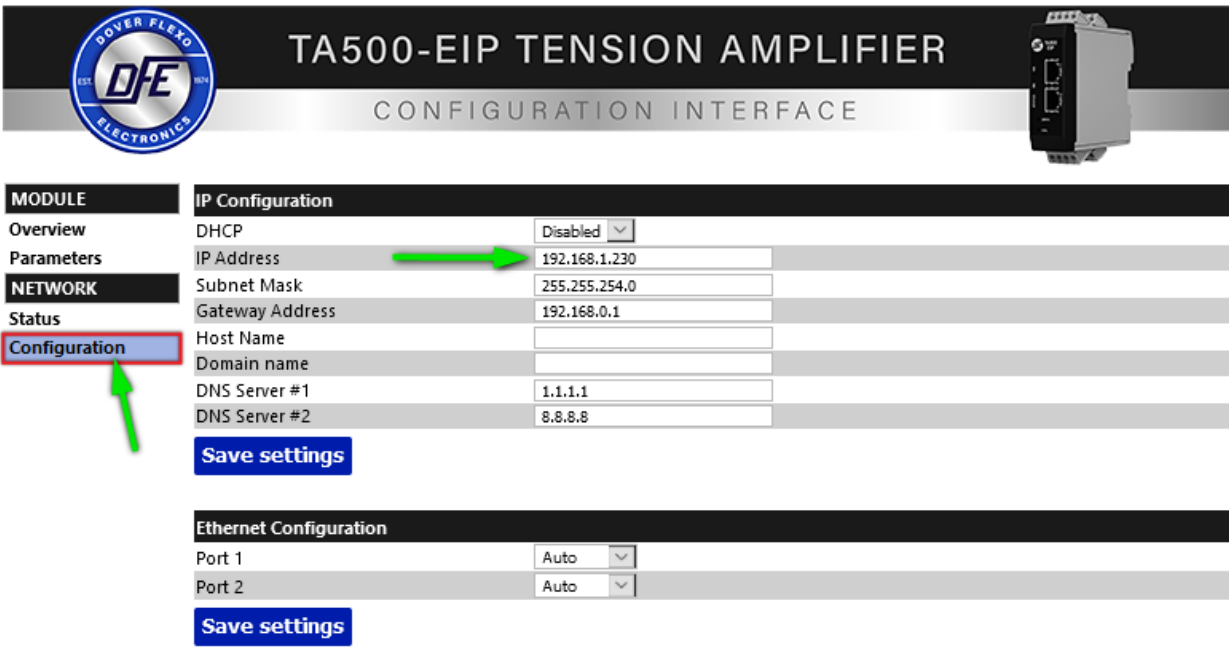

DOVER FLETO
D/E
ELECTRONICS

TA500-EIP TENSION AMPLIFIER

CONFIGURATION INTERFACE

MODULE

Overview

Parameters

NETWORK

Status

Configuration

IP Configuration

DHCP	Disabled
IP Address	192.168.1.230
Subnet Mask	255.255.254.0
Gateway Address	192.168.0.1
Host Name	
Domain name	
DNS Server #1	1.1.1.1
DNS Server #2	8.8.8.8

Save settings

Ethernet Configuration

Port 1	Auto
Port 2	Auto

Save settings

6.3 CHECKING ACTIVE CONNECTIONS

Using the Web Interface Navigate to Status

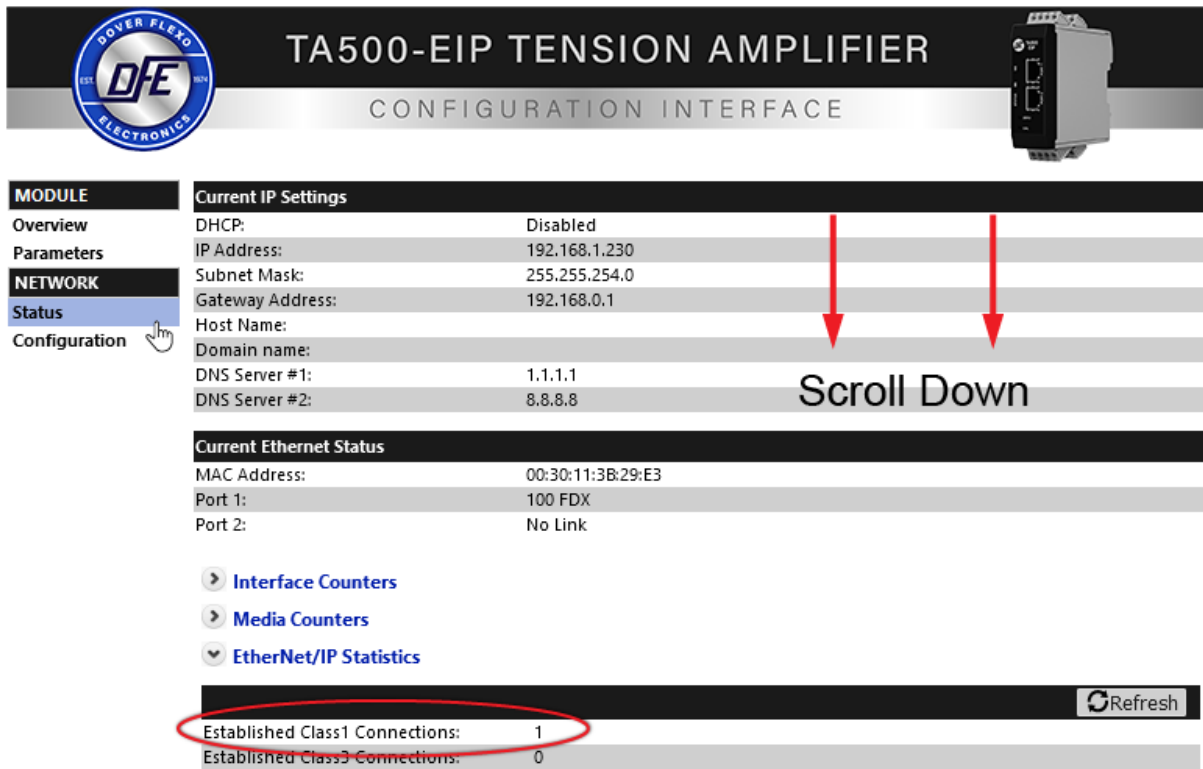

DOVER FLETO
D/E
ELECTRONICS

TA500-EIP TENSION AMPLIFIER

CONFIGURATION INTERFACE

MODULE

Overview

Parameters

NETWORK

Status

Configuration

Current IP Settings

DHCP:	Disabled
IP Address:	192.168.1.230
Subnet Mask:	255.255.254.0
Gateway Address:	192.168.0.1
Host Name:	
Domain name:	
DNS Server #1:	1.1.1.1
DNS Server #2:	8.8.8.8

Scroll Down

Current Ethernet Status

MAC Address:	00:30:11:3B:29:E3
Port 1:	100 FDX
Port 2:	No Link

- ▶ [Interface Counters](#)
- ▶ [Media Counters](#)
- ▼ [EtherNet/IP Statistics](#)

Established Class1 Connections:	1
Established Class3 Connections:	0

Refresh

The TA500-EIP also indicates active connections using the status LEDs at the front of the device. When an established connection is active the Network status LED will be solid green. For more information see the section **Network Status (NS) LED**.

TERMS AND CONDITIONS OF SALE AND SHIPMENT

1. THE COMPANY

Dover Flexo Electronics, Inc. is here in after referred to as the Company.

2. CONFLICTING OR MODIFYING TERMS

No modification of, additions to or conflicting provisions to these terms and conditions of sale and shipment, whether oral or written, incorporated into Buyer's order or other communications are binding upon the Company unless specifically agreed to by the Company in writing and signed by an officer of the Company. Failure of the Company to object to such additions, conflicts or modifications shall not be construed as a waiver of these terms and conditions nor an acceptance of any such provisions.

3. GOVERNING LAW

This contract shall be governed by and construed according to the laws of the state of New Hampshire, U.S.A. The parties agree that any and all legal proceedings pursuant to this contract shall take place under the jurisdiction of the courts of the State of New Hampshire in the judicial district of Strafford County.

4. PENALTY CLAUSES

Penalty clauses of any kind contained in orders, agreements or any other type of communication are not binding on the Company unless agreed to by an officer of the Company in writing.

5. WARRANTY

Dover Flexo Electronics, Inc. warrants, to the original Buyer, its' products to be free of defects in material and workmanship for five years from date of original shipment. Repairs on products are warranted for 90 days from date of shipment. During the warranty period the Company will repair or replace defective products free of charge if such products are returned with all shipping charges prepaid and if, upon examination, the product is shown to be defective. This warranty shall not apply to products damaged by abuse, neglect, accident, modification, alteration or mis-use. Normal wear is not warrantied. All repairs and replacements under the provisions of this warranty shall be made at Dover Flexo Electronics or at an authorized repair facility. The Company shall not be liable for expenses incurred to repair or replace defective products at any other location or by unauthorized persons or agents. This warranty contains all of the obligations and warranties of the Company. There are no other warranties, either expressed or implied. No warranty is given regarding merchantability or suitability for any particular purpose. The Company shall not be liable in either equity or law for consequential damages, losses or expenses incurred by use of or inability to use its' products or for claims arising from same. No warranty is given for products of other manufacturers even though the Company may provide these products with its' own or by themselves. The provisions of this warranty cannot be changed in any way by any agent or employee of the Company. Notice of defects must be received within the warranty period or the warranty is void. The warranty is void if the serial number tag is missing or not readable.

6. PAYMENTS

Standard terms of credit are net 30 days from date of shipment, providing satisfactory credit is established with the Company. Amounts past due are subject to a service charge of 1.5% per month or portion thereof or 18% per annum. The Company reserves the right to submit any unpaid late invoices to a third party for collection and Buyer shall pay all reasonable costs of such collection in addition to the invoice amount. All quoted prices and payments shall be in U.S. Dollars. If the Company judges that the financial condition or payment practices of the Buyer does not justify shipment under the standard terms or the terms originally specified, the Company may require full or partial payment in advance or upon delivery. The Company reserves the right to make collection on any terms approved in writing by the Company's Finance Department. Each shipment shall be considered a separate and independent transaction and payment therefore shall be made accordingly. If the work covered by the purchase order is delayed by

the Buyer, upon demand by Company payments shall be made on the purchase price based upon percentage of completion.

7. TAXES

Any tax, duty, custom, fee or any other charge of any nature whatsoever imposed by any governmental authority on or measured by any transaction between the Company and the Buyer shall be paid by the Buyer in addition to the prices quoted or invoiced.

8. RETURNS

Written authorization (MRA) must be obtained from the Company's factory before returning any material for which the original Buyer expects credit, exchange, or repairs. Material returned for credit must be unused, received back within 30 days of original ship date and shall be subject to a re-stocking charge of 15%. Special Product Requests (SPRs), product manufactured specially to customer specifications, and non-DFE product purchased on customer behalf shall not be returnable for any reason. All material returned, for whatever reason, shall be sent with all freight charges prepaid by the Buyer.

9. SHIPPING METHOD AND CHARGES

All prices quoted are EXW the Company's factory. The Company shall select the freight carrier, method and routing. Shipping charges are prepaid and added to the invoice of Buyers with approved credit, however the Company reserves the right to ship freight-collect if it prefers. Shipping charges will include a charge for packaging. Company will pay standard ground freight charges for items being returned to Buyer which are repaired or replaced under the Warranty. Claims of items missing from a shipment must be received, in writing, within 30 days of original shipment

10. CANCELLATION, CHANGES, RESCHEDULING

Special Product Requests (SPRs), product manufactured specially to customer specifications, and non-DFE product purchased on customer behalf shall not be returnable for any reason. Buyer will be subject to a 15% fee for any standard item on order with the Company which is cancelled by the Buyer. A one-time hold on any item ordered from the Company shall be allowed for a maximum of 30 days. After 30 days, or upon notice of a second hold, Company shall have the right to cancel the order and issue the appropriate cancellation charges which shall be paid by Buyer. Items held for the Buyer shall be at the risk and expense of the Buyer unless otherwise agreed upon in writing. Company reserves the right to dispose of cancelled material as it sees fit without any obligation to Buyer. If Buyer makes, or causes to make, any change to an order the Company reserves the right to change the price accordingly.

11. PRICES

Prices published in price lists, catalogs or elsewhere are subject to change without notice and without obligation. Written quoted prices are valid for thirty days only.

12. EXPORT SHIPMENTS

Payment for shipments to countries other than the U.S.A. and Canada or to authorized distributors shall be secured by cash in advance or an irrevocable credit instrument approved by an officer of the Company. An additional charge will apply to any letter of credit. There will also be an extra charge for packaging and documentation.

13. CONDITION OF EQUIPMENT

Buyer shall keep products in good repair and shall be responsible for same until the full purchase price has been paid.

14. OWNERSHIP

Products sold are to remain the property of the Company until full payment of the purchase price is made.

Rev.10 10/15/19



307 PICKERING ROAD
ROCHESTER, NEW HAMPSHIRE 03867-4630
U.S.A

TEL: (603) 332-6150
FAX: (603) 332-3758

E-mail: info@dfe.com Internet: www.dfe.com

CANADA

EUROPE

MEXICO

UNITED KINGDOM

TAIWAN

KOREA

CHINA

INDIA

AUSTRALIA

SOUTH AFRICA